

Installation Manual Double DIN Kit

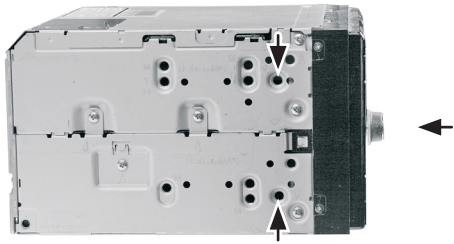

(sample photo)

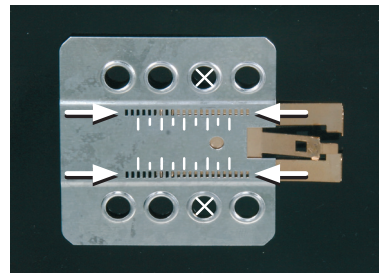

(sample photo)

Mount the metal brackets to the double DIN head unit.

The position of the copper coloured holder can be adjusted to your needs for perfect fit. (see sample)



8. Connect all required circuit points and push the double DIN head unit in the metal frame until it snaps in



9. Place facia plate



Installation Manual Double DIN Kit

Part-No.: 381040-13

- Citroën Nemo 2008->
- Fiat Fiorino 2008->
- Peugeot Bipper 2008->

Compatible with double DIN devices

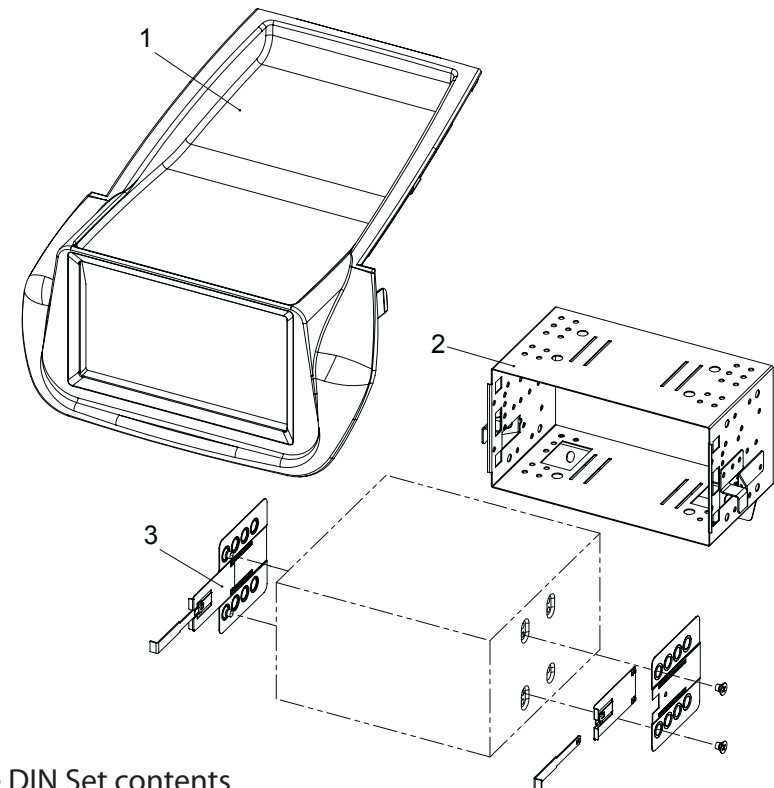

Double DIN Set contents

- (1) Facia Plate
- (2) Metal Frame
- (3) Mounting Accessories



1. Remove OEM Radio with special radio release keys

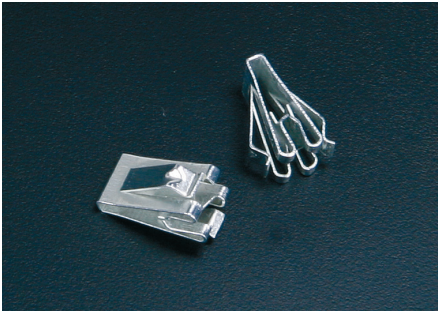

2. Remove original clamps from upper OEM-cover



Info: Attach original clamps from upper OEM-cover to fascia plate (see arrows)

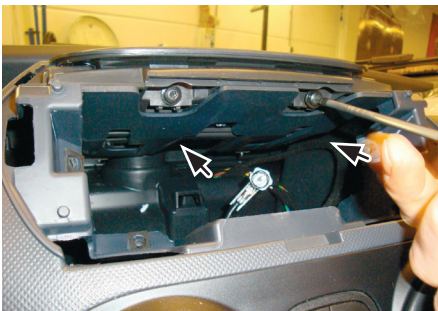

3. Remove 2 screws (see arrows)

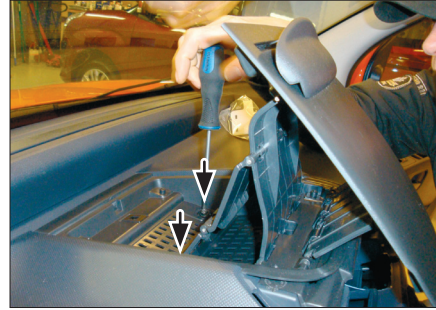

4. Remove 2 screws below document holder

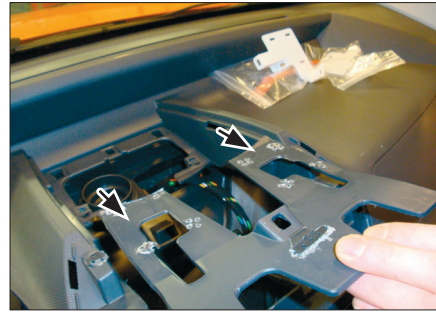

5. Cut out dash board plastic by using a sharp knife



6. Note: Cutting needs to be done properly for a seamless installation of the double DIN head unit

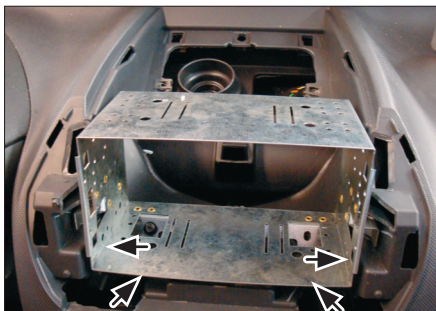

7. Place metal frame fix metal frame with 4 screws