

Installation Manual Double DIN Kit

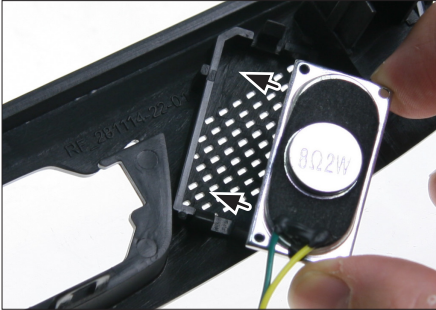

20. as needed fix speaker with cyanoacrylate adhesive

Spare OEM hazard light switch by Ford required. Ford Part-No.: 1519127



20. Mount
- air vents
- hazard light switch to facia plate

Push facia plate on dash board until it snaps in



21. Fix facia plate with 2 OEM screws (see arrows)



22. Re-install everything in reverse order to finish installation



Installation Manual Double DIN Kit

lead cable (for)	piano black	dark grey	dark brown
Alpine	381114-22-1-1	381114-22-2-1	381114-22-3-1
Blaupunkt	381114-22-1-5	381114-22-2-5	381114-22-3-5
Becker	381114-22-1-0	381114-22-2-0	381114-22-3-0
Clarion	381114-22-1-8	381114-22-2-8	381114-22-3-8
JVC	381114-22-1-9	381114-22-2-9	381114-22-3-9
Kenwood	381114-22-1-7	381114-22-2-7	381114-22-3-7
Panasonic	381114-22-1-2	381114-22-2-2	381114-22-3-2
Pioneer	381114-22-1-3	381114-22-2-3	381114-22-3-3
Sony	381114-22-1-6	381114-22-2-6	381114-22-3-6
Zenec	381114-22-1-4	381114-22-2-4	381114-22-3-4

Ford C-MAX 2010->

Spare OEM hazard light switch by Ford required. Ford Part-No.: 1519127



Compatible with these double DIN devices

Double DIN Navigation

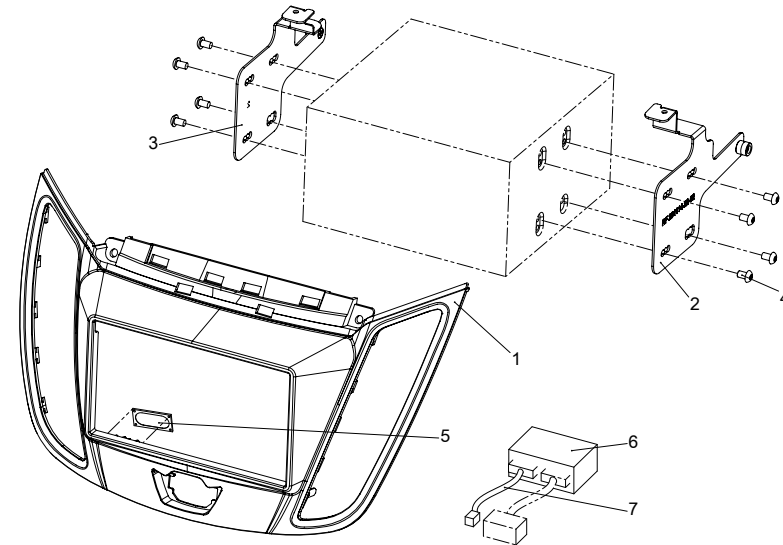

Double DIN Kit contents

- (1) Facia Plate
- (2) Mounting Bracket right
- (3) Mounting Bracket left
- (4) flat headed screws
- (5) replacement speaker
- (6) stalk adapter
- (7) lead cable (see part-no.)

Installation Manual Double DIN Kit



1. Ford C-MAX with OEM radio

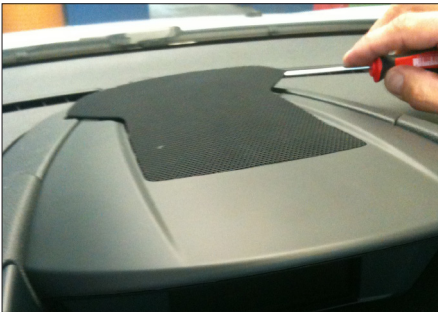

2. Unclip speaker grill at top of dash board carefully

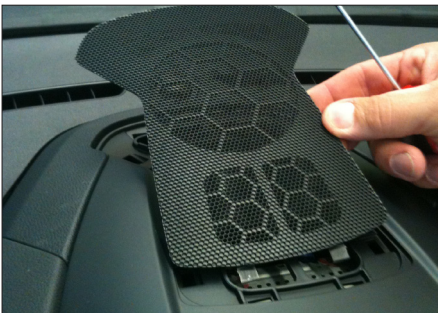

3. Remove speaker grill



4. Unclip cover of center console



17. Dashboard after plastic cut out

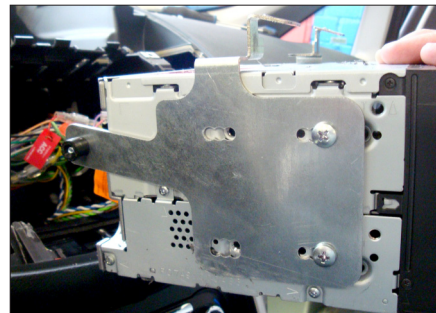

18. Fix mounting brackets to Double DIN head unit

Connect all required circuit points

Push Double DIN head unit into dash board

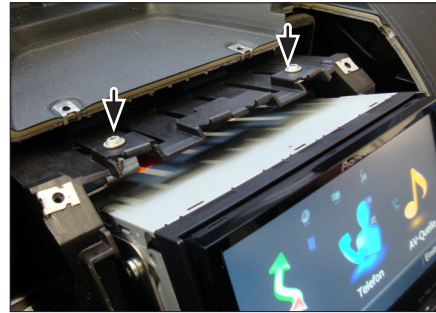

19. Fix Double DIN head unit

Installation Manual Double DIN Kit

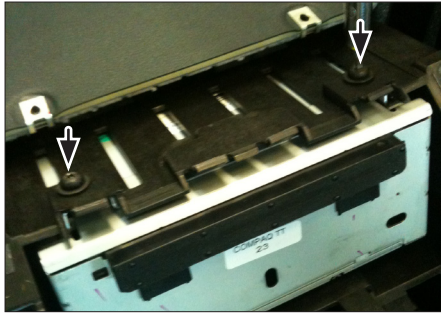

14. Remove screws of OEM Radio/CD unit

Remove OEM Radio/CD unit



15. Cut away plastic to clear space for Double DIN head unit

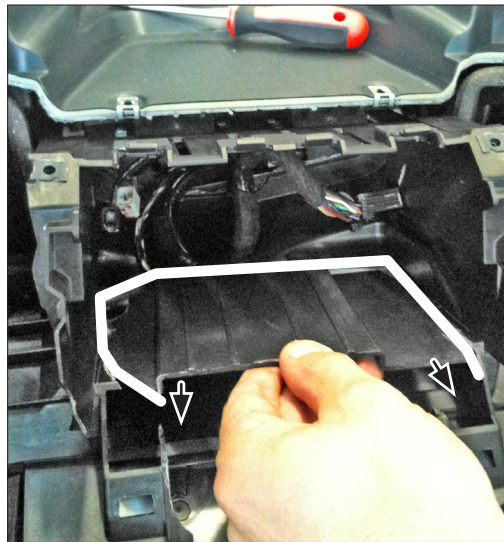

16. Remove plastic



6



5. Remove screws of center console



6. Unclip cover center console



7. Remove top panel cover

3

Installation Manual Double DIN Kit



8. Unclip display



9. Remove display



10. Unclip center panel

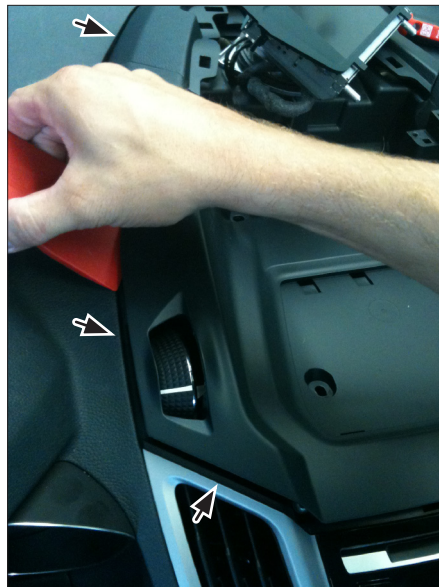

11. Remove screw (see arrow)



4



12. Remove screws on top of OEM head unit (left and right)



13. Unclip air vents
Remove air vents

5