

Kit Preparation

1. Hyundai Accent: Cut and remove shaded areas. (Figure A)
2. Kia Rio: Cut and remove shaded areas. (Figure B)
3. Kia Sportage: Cut and remove shaded areas. (Figure C)

Continue to kit assembly

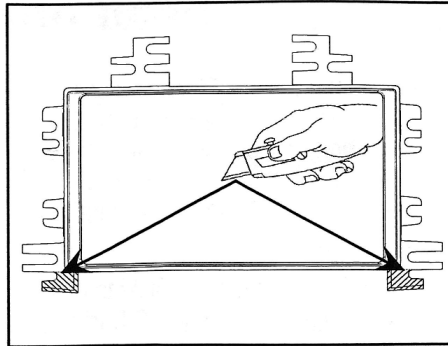

(Figure A)

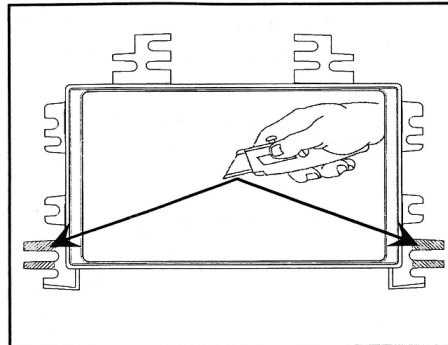

(Figure B)

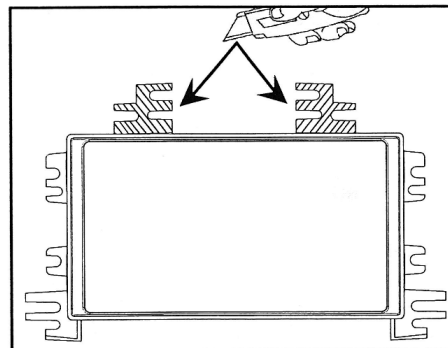

(Figure C)



Installation Manual Double DIN Kit

Part-No.: 281178-04

Hyundai Accent 2006-2011
Kia Rio / RIO 5 2006->
Kia Sportage 2005-2010

KIT FEATURES

- DDIN head unit provision
- ISO stacked head unit provision

KIT COMPONENTS

- A) DDIN radio housing
- B) DDIN radio housing brackets

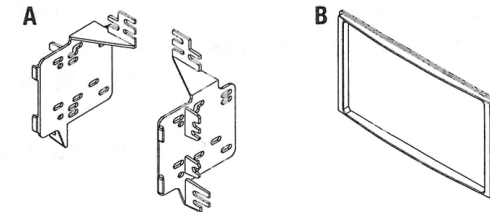

TOOLS REQUIRED

Panel Removal Tool • Phillips Screwdriver • Small Flat Blade Screwdriver • Cutting Tool

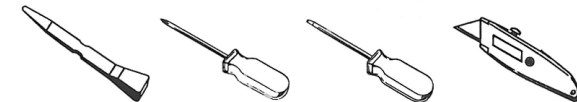

Installation Manual

Hyundai Accent 2006-2011 Kia Rio/RIO 5 2006-up

1. Unclip and remove the trim panel surrounding the radio and including the a/c vents. (Figure A)
2. Remove (4) Phillips screws securing the radio. (Figure B)

Continue to kit preparation

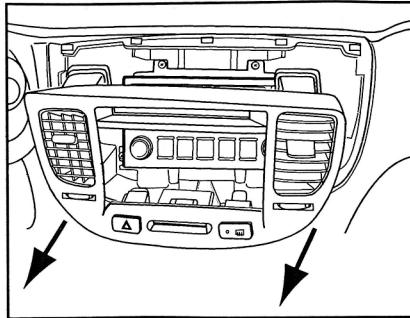

(Figure A)

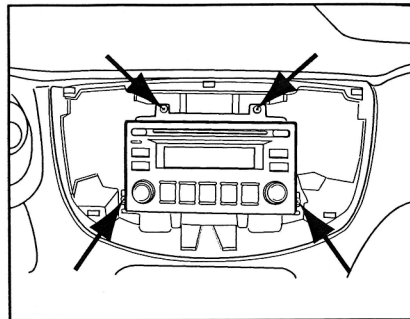

(Figure B)

Kia Sportage 2005-2010

1. Unclip and remove the entire panel surrounding the radio and including the A/C controls. **Note: Start at bottom of panel.** (Figure A)
2. Remove (4) Phillips screws to extract radio from dash. (Figure B)

Continue to kit preparation

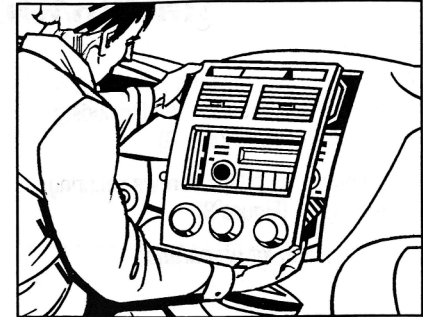

(Figure A)

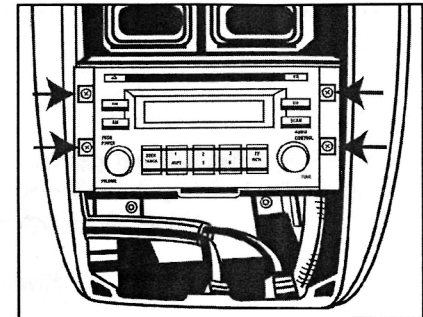

(Figure B)