

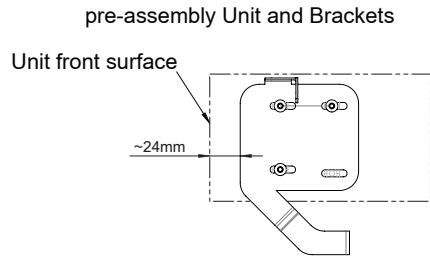

## Installation Manual Double DIN Kit

piano-black:

381210-17-1



8. Mount mounting brackets with flat headed screws to Double-DIN head unit

We recommend to leave about 24 mm space to the unit front surface

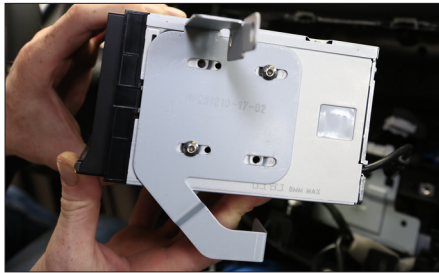

9. Connect all required circuit points. Place Double-DIN head unit on dash board  
Fix it with 4 screws



10. Put clips on the rear side of fascia plate. Place fascia plate on dash board

Reinstall everything in reverse order to finish installation

### • Nissan Qashqai (J11) 02/2014->

Compatible with these double DIN devices

#### Double-DIN Navigation

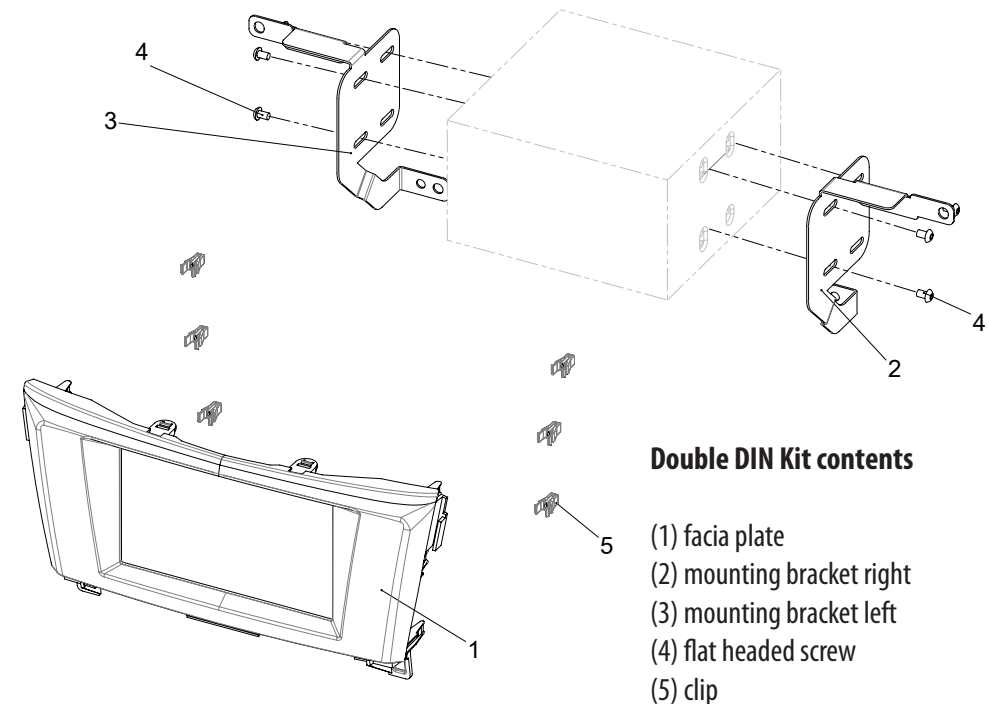



1. Unclip air condition control unit under OEM head unit

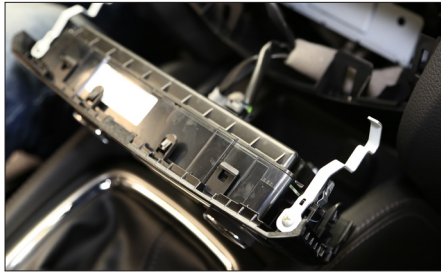

2. Remove air condition control unit

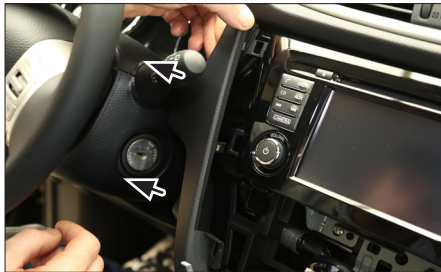

3. Remove panel at left side



4. Remove panel at right side



5. Remove all screws of OEM head unit

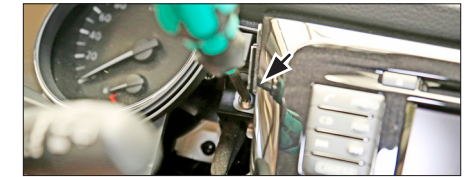

left side



right side

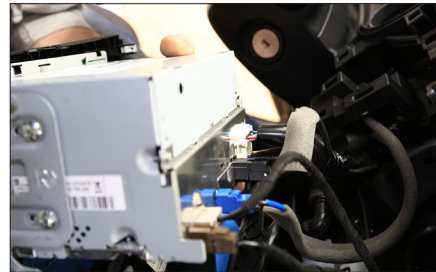

6. Unplug all cables of OEM head unit

Remove OEM head unit



7. Dash board after removal of OEM head unit