

## ANTENNAS | PUCK-5 SERIES

### 5-IN-1 TRANSPORTATION & IOT/M2M ANTENNA

698 - 3800 MHz; 2X2 LTE (MIMO), 6 dBi; 2X2 Wi-Fi (MIMO), 7.5 dBi; GPS/GLONASS, 21 dBi

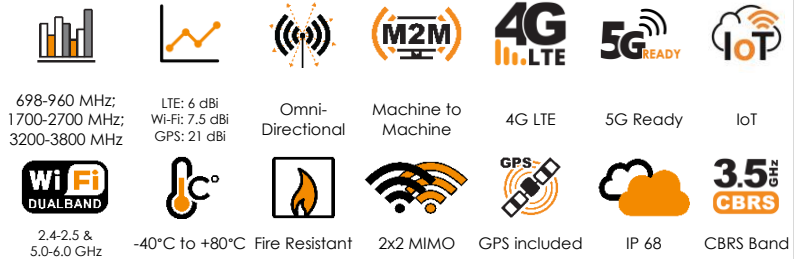

- **5-in-1 LTE high performance multi frequency**
- **2G/3G/4G/LTE antenna (5G Ready)**
- **LTE (2X2 MIMO), Dual-band Wi-Fi (2X2 MIMO), GPS/GLONASS**
- **Wideband – covers wide frequency band, incl. 3.5 GHz CBRS band**
- **Ground plane independent**
- **Robust, vandal resistant and waterproof (IP 68)**
- **Ideal for transportation, marine and IoT/M2M use**
- **Ultra-versatile mounting options for easy installation**

## Product Overview

Poynting's new PUCK antenna offers a small profile antenna for use in the IoT/M2M, Smart Meter, Smart Utilities, Transportation, Marine and the Agricultural/Farming markets. The PUCK-5 consists of a 5-in-1 antenna system within a single housing, featuring 2X2 MIMO LTE, 2X2 MIMO Wi-Fi (Dual-band 2.4 GHz & 5 GHz) and GPS/GLONASS. The 2x Cellular MIMO antennas (for 2G/3G/4G) cover the 698 MHz to 3800 MHz band, this includes the most popular international LTE bands. The antenna provides two separate dual-band Wi-Fi antennas offering concurrent 2.4GHz and 5 GHz bands, capable of 802.11n and 802.11ac/ax with 2x2 MIMO. The fifth antenna is a high-performance active GPS/GLONASS system operating at temperatures as low as -40°C. The PUCK exceeds the performance of many competitors due to the attention to design of this high-performance antenna. The radiation patterns of all radiating elements provide an excellent balance between omnidirectionality, pattern diversity and good radiation abilities at the desired elevation, which is often overlooked in such a small size antenna. Despite its small size, this antenna provides excellent performance especially at the higher frequency bands, where performance is critical for LTE throughput and connection stability. This antenna is designed so that both the LTE ports are connected to the router/device to ensure the best performance. Please see other derivatives of the PUCK range that are more suitable for a SISO application.

## Features

- Small & Low-Profile (100mm x h 36mm)
- Careful mechanical design provides ruggedness, corrosion, water, dust resistance (IP68)
- Fire Resistant
- UV Stable Enclosure
- Ground plane independent – performs consistently with and without a ground plane
- 5G Ready; includes 3.2GHz to 3.8GHz CBRS Band
- Easy installation; multi implementation options (as standard)
  - Spigot Mount
  - Magnetic Mount
  - Adhesive Tape Mount
  - Bracket Mount

## Application Areas

- Smart Utilities: Smart Power, Gas & Water Metering
- Smart Buildings: Climate control, access control, security, irrigation
- Digital Signage
- Warehouses & Logistic systems
- Industrial factory automation, robotic machinery and other M2M systems
- Transport (Busses, Utility & Public Safety)
- Mining Vehicles & Machinery communications, telemetry and automation (M2M & IoT)
- Agricultural machinery
- Marine: small boats, yachts near to coastlines or inner waters.



### Frequency Bands – Cellular & Wi-Fi

The PUCK-5 is suitable for the following Cellular frequency bands | 698-960 MHz | 1710-3800 MHz | and the following Wi-Fi frequency bands | 2400-2500 MHz | 5000-6000 MHz |

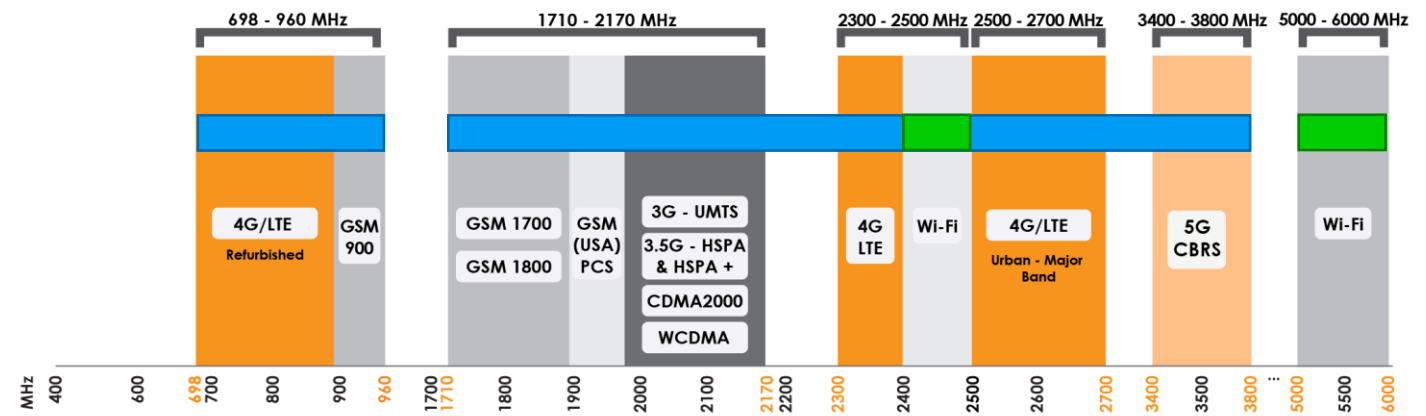

■ Indicates the 5G/LTE bands on which PUCK-5 works      ■ Indicates the Wi-Fi bands on which PUCK-5 works

### Antenna Derivatives

Product Order Code (SKU)	A-PUCK-0005-V1-01	A-PUCK-0005-V1-01-W
Radome colour	Black	White
Ports	5	5
SISO / MIMO	2x2 MIMO	2x2 MIMO
Coax Cable Type	RTK-031	RTK-031
Coax Cable Length	2m	2m
Connector Type	SMA (M)	SMA (M)
EAN	6009880915170	6009710920817

*\*The coax cable & connector are factory mounted to the antenna*

## Electrical Specifications - Cellular

Frequency bands:	698-960 MHz 1710-2700 MHz 3200-3800 MHz
Gain (max) Port 1 & 2:	-1 dBi @ 698-960 MHz 6 dBi @ 1710-2700 MHz 6 dBi @ 3200-3800 MHz
VSWR Port 1 & 2:	≤2.5:1 over 85% of the band
Feed power handling:	10 W
Input impedance:	50 Ohm (nominal)
Polarisation:	Linear Vertical
Coax cable loss:	0.56 dB/m @ 900 MHz 0.72 dB/m @ 1800 MHz 1.2 dB/m @ 3000 MHz
DC Short:	Yes

## GPS/Glonass Antenna Electrical Specifications

Frequency Range (GPS):	1575.42MHz/1600MHz
Gain (Max):	21+/-2dBi
VSWR:	≤1.5:1
DC Voltage:	2.7-3.3 V
DC Current:	5-15mA
Noise Figure:	≤1.5 dB
Nominal Impedance:	50 Ω
Polarisation:	RHCP
Filter Out Band Attenuation:	12dB Min f0+50MHz, 16dBi Min f0-50MHz
Cable:	RTK-031
Connector:	SMA male
Voltage:	2.7 - 3.3V
Max. Power-W:	50
Coax cable loss:	0.65 dB/m @ 1500 MHz

## Wi-Fi Electrical Specifications

Frequency:	2400-2500 MHz 5000-6000 MHz
Gain (Max) Port 1 & 2:	5dBi @ 2400-2500 MHz 7.5dBi @ 5000-6000 MHz
VSWR Port 1 & 2:	≤2:1 over 95% of the band
Feed power handling:	10 W
Nominal input impedance:	50 Ohm (nominal)
Polarisation:	Linear Vertical
Coax cable loss:	0.88 dB/m @ 2400 MHz 1.65 dB/m @ 5800 MHz
Path to Ground:	Yes

## Product Box Contents

Antenna:	A-PUCK-0005-V1-01
Mounting bracket:	Ø20 Threaded Spigots (Up to 60mm clamping thickness), Adhesive Surface Mounting & Magnetic Mount
Adapters:	2x RP-SMA(m) To SMA (f)

## Mechanical Specifications

Product dimensions	Ø99.3 mm x 36 mm
Packaged dimensions:	150 mm x 150mm x 120mm
Weight:	0.523kg
Packaged weight:	0.654kg
Radome material:	PC+ABS (Halogen free)
Mounting Type:	Ø20 Threaded Spigot, Pole, Wall, Surface and Magnetic mount

## Environmental Specifications, Certification & Approvals

Wind Survival:	≤220 km/h
Temperature Range (Operating):	-40°C to +80°C
Environmental Conditions:	Outdoor/Indoor
Water ingress protection ratio/standard:	IP 68 – 30 minutes up to 1.5m
Salt Spray:	MIL-STD 810F/ASTM B117
Operating Relative Humidity:	Up to 98%
Storage Humidity:	5% to 95% - non-condensing
Storage Temperature:	-40°C to +80°C
Enclosure Flammability Rating:	UL 94-HB, ECE-R1 18.02 Certified cables
Impact resistance:	IK 10
Product Safety & Environmental:	Complies with CE and RoHS standards



Technical Drawings

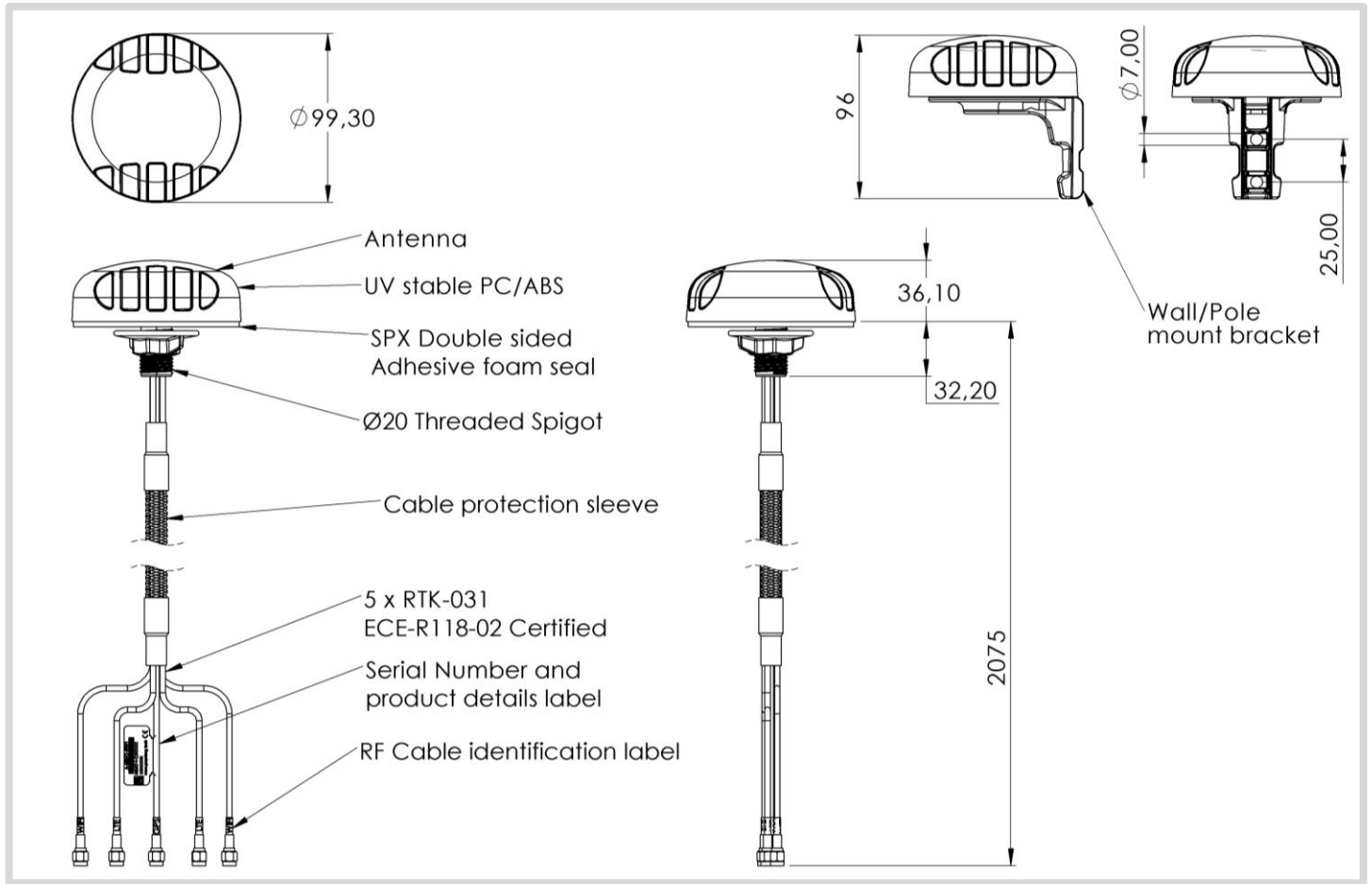

**Antenna Performance Plots**

**VSWR: Cellular Antenna**

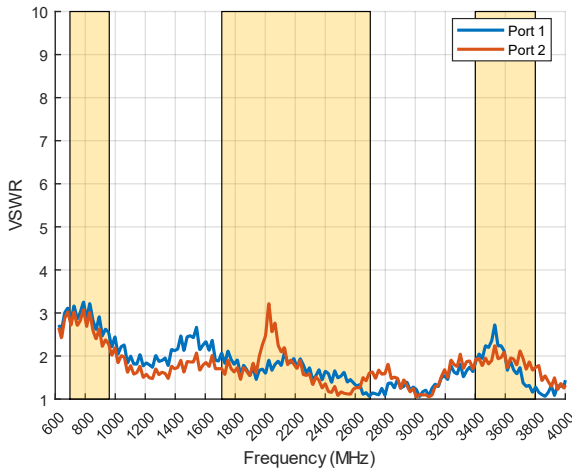

**Voltage Standing Wave Ratio (VSWR)\***

VSWR is a measure of how efficiently radio-frequency power is transmitted from a power source, through a transmission line, into a load. In an ideal system, 100% of the energy is transmitted which corresponds to a VSWR of 1:1.

The PUCK-5 delivers superior performance across all bands with a VSWR of  $\leq 2.5:1$  over 85% of the band

\*Measured with 2m low loss cable

\*Measured with 50Ω load terminated to unused port

**Gain: Cellular Antenna**

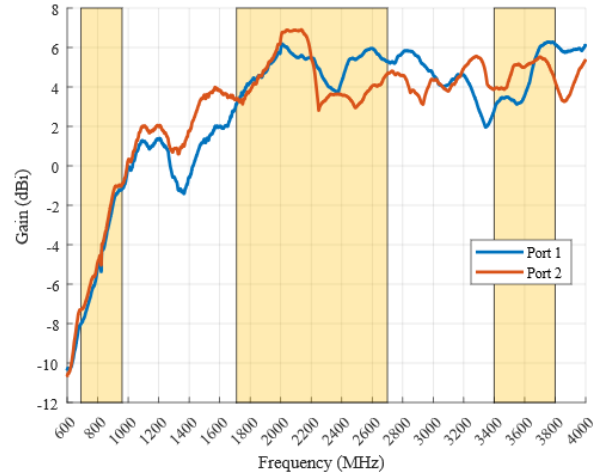

**Gain in dBi**

6 dBi is the peak gain across all bands from 698-960, 1710-2700 & 3400-3800 MHz

Peak Gain @ 698-960MHz:	-1 dBi
Peak Gain @ 1710-2700MHz:	6 dBi
Peak Gain @ 3400-3800MHz:	6 dBi

**VSWR: Wi-Fi Antenna**

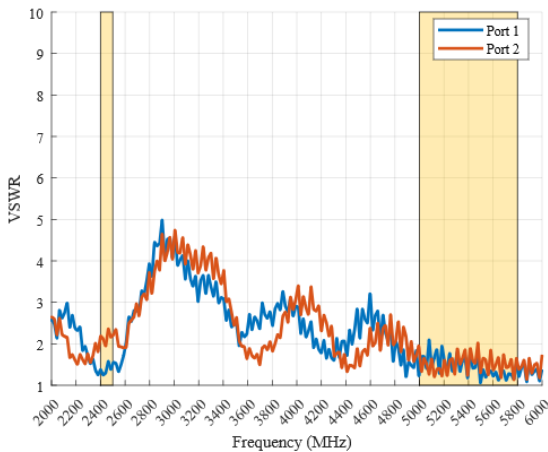

**Voltage Standing Wave Ratio (VSWR)\***

VSWR is a measure of how efficiently radio-frequency power is transmitted from a power source, through a transmission line, into a load. In an ideal system, 100% of the energy is transmitted which corresponds to a VSWR of 1:1.

The PUCK-5 delivers superior performance across all bands with a VSWR of  $\leq 2:1$  over 95% of the band

\*Measured with 2m low loss cable

**Gain: Wi-Fi Antenna**

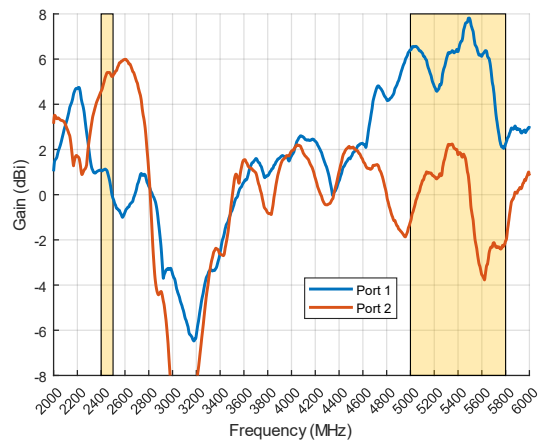

**Gain in dBi**

7.5 dBi is the peak gain across all bands from 2400-2500 & 5000 – 5800 MHz

Peak Gain @2400-2500MHz:	5 dBi
Peak Gain @5000-5800MHz:	7.5 dBi

**Radiation Patterns – Cellular**

Azimuth (Top View): 698–960 MHz

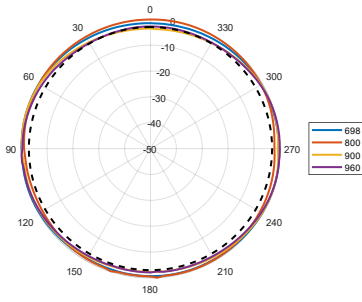

Azimuth (Top View): 1710–2100 MHz

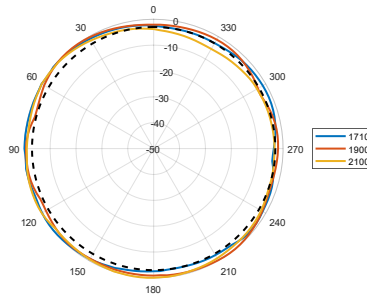

Azimuth (Top View): 2300–2700 MHz

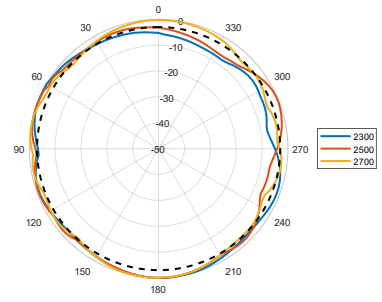

Azimuth (Top View): 3400–3800 MHz

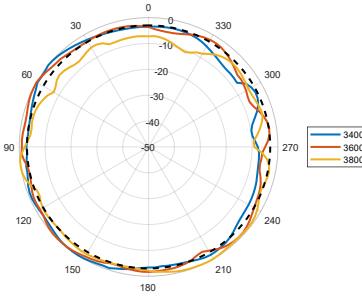

Elevation1 (Side View): 698–960 MHz

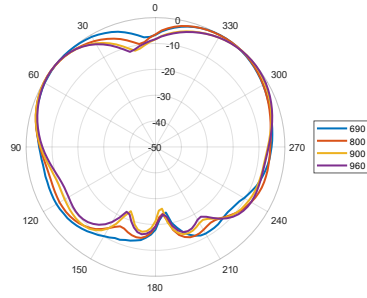

Elevation1 (Side View): 1710–2100 MHz

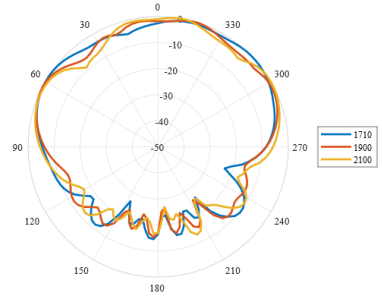

Elevation1 (Side View): 2300–2700 MHz

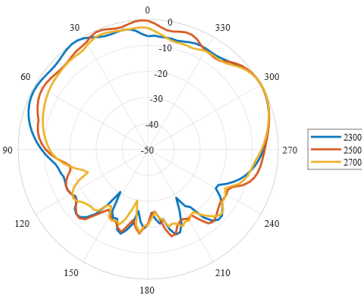

Elevation1 (Side View): 3400–3800 MHz

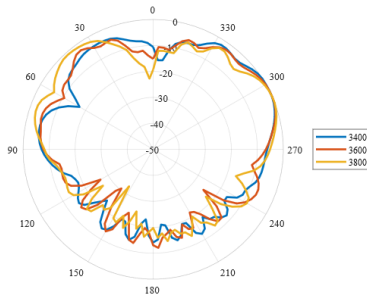

Elevation2 (Side View): 698–960 MHz

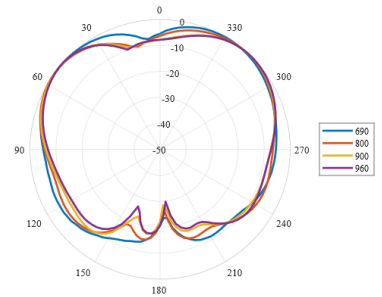

Elevation2 (Side View): 1710–2100 MHz

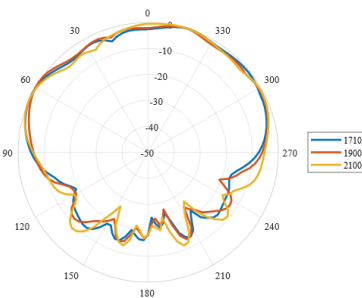

Elevation2 (Side View): 2300–2700 MHz

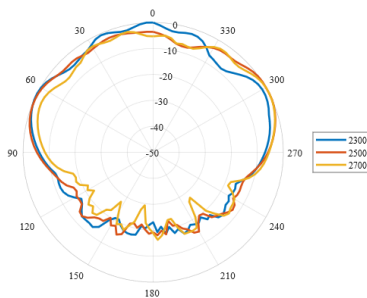

Elevation2 (Side View): 3400–3800 MHz

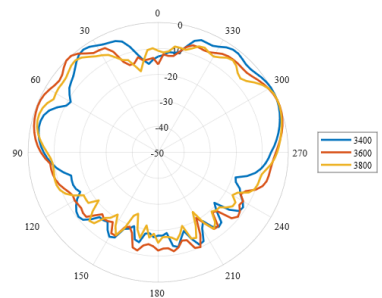

**Radiation Patterns – Wi-Fi**

Azimuth (Top View): 2400–2500 MHz

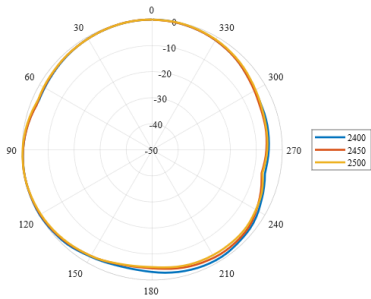

Azimuth (Top View): 5000–5400 MHz

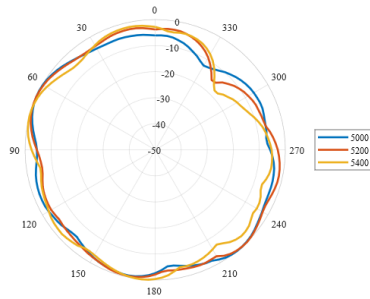

Azimuth (Top View): 5600–5800 MHz

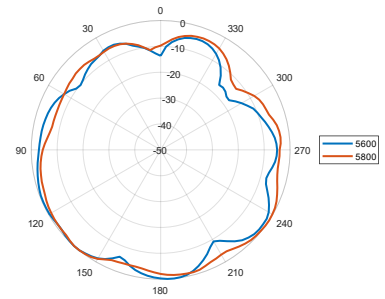

Elevation1 (Side View): 2400–2500 MHz

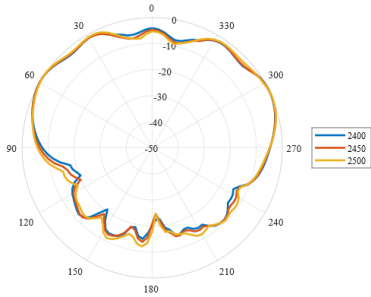

Elevation1 (Side View): 5000–5400 MHz

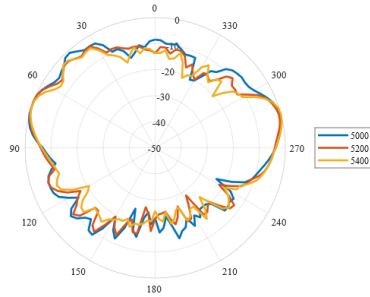

Elevation (Side View): 5600–5800 MHz

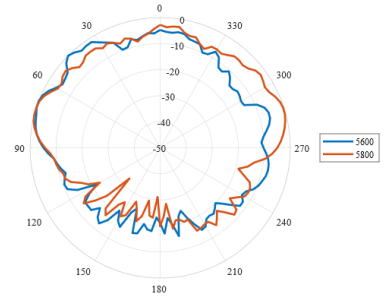

Elevation2 (Side View): 2400–2500 MHz

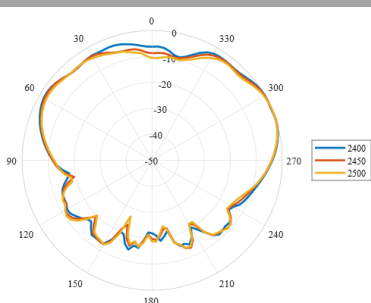

Elevation2 (Side View): 5000–5400 MHz

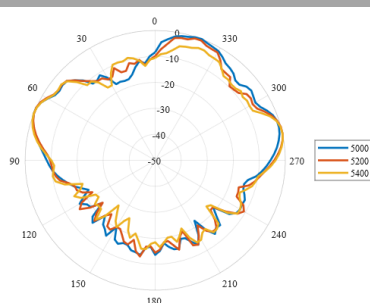

Elevation2 (Side View): 5600–5800 MHz

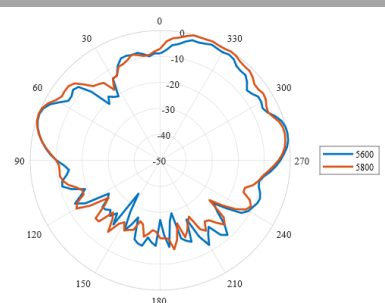

**Radiation Patterns – GPS**

XY Plane: 1561–1602 MHz

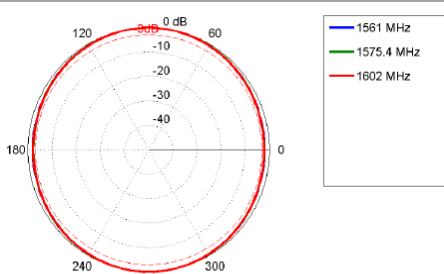

XZ Plane: 1561–1602 MHz

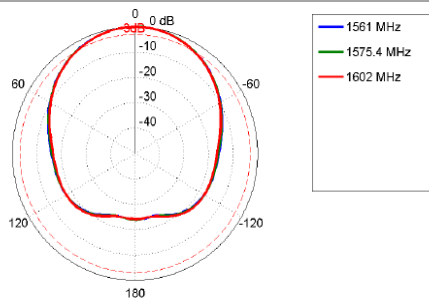

YZ Plane: 1561–1602 MHz

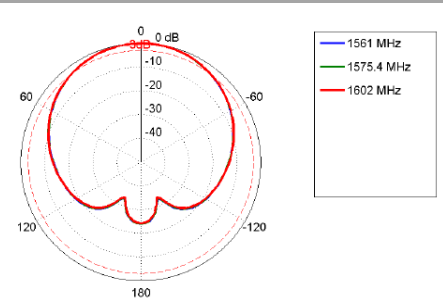

**Mounting Options**

**Many Mounting Possibilities – included as standard**

Poynting's new PUCK antenna range provides easy installation with the multiple mounting options. This includes as standard:

- Spigot Mount - two different lengths included (40mm & 80mm)
- Vertical Pole mount (inner & outer mounting for smaller and larger poles)
- Horizontal Pole Mount (e.g. marine rails)
- Magnetic Mount
- Surface Mount (Double Sided Tape)
- Wall Mount

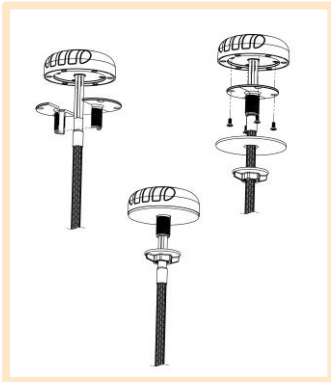

**Spigot Mount**

Removable 40mm & 80mm threaded spigot (included)

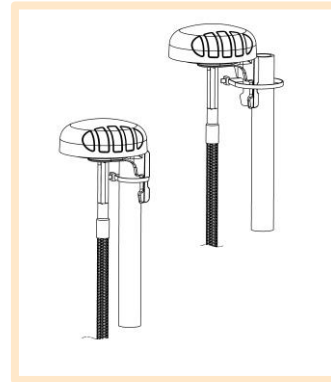

**Vertical Pole Mount**

Pole/Wall Mounting bracket (included)

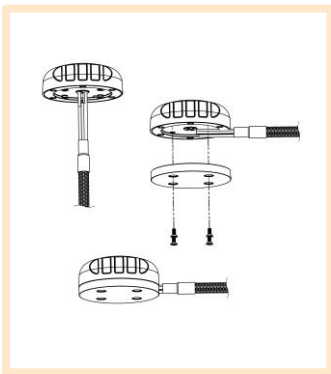

**Magnetic Mount**

Magnetic Base (included)  
For temporary and low mobility installations.

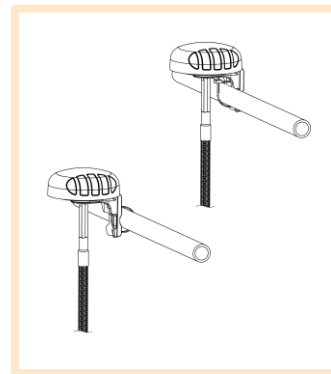

**Horizontal Pole Mount**

Pole/Wall Mounting bracket (included)

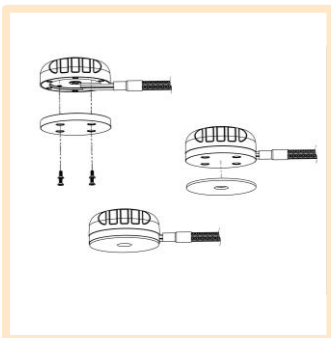

**Surface Mount**

Adhesive Surface Mounting (included) or can also be directly secured with longer M4 bolts (not included) to the female threaded inserts located in the antenna base

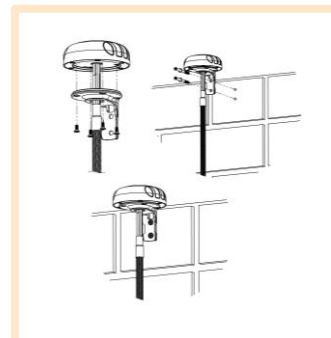

**Wall Mount**

Pole/Wall Mounting bracket (included)