

KW-M27DBT

MONITOR WITH RECEIVER

Quick Start Guide

ÉCRAN AVEC RÉCEPTEUR

Guide de démarrage rapide

MONITOR MIT EMPFÄNGER

Kurzanleitung

MONITOR MET ONTVANGER

Snelstartgids

MONITOR CON RICEVITORE

Guida rapida

MONITOR CON RECEPTOR

Guía de inicio rápido

MONITOR COM RECETOR

Guia de Iniciação Rápida

JVCKENWOOD Corporation

Model name indication position

See "Removing the trim plate" (P.13)

Position d'indication du nom du modèle

Reportez-vous à la section « Retrait de la plaque de garniture » (p.29)

Anzeigeposition der Modellbezeichnung

Siehe „Entfernen der Ziertafel“ (S.45)

Model naam indicatie positie

Zie "Verwijderen van de afwerkingsplaat" (P.61)

Posizione di indicazione del nome del modello

Fare riferimento a "Rimozione della piastra di taglio" (P.77)

Posición de la indicación del nombre del modelo

Consulte "Retirada del marco" (P.93)

Posição da indicação do nome do modelo

Consulte "Retirar a moldura" (P.109)

Trim plate
Plaque de garniture
Zierplatte
Afwerkingsplaat
Piastra di taglio
Marco
Moldura

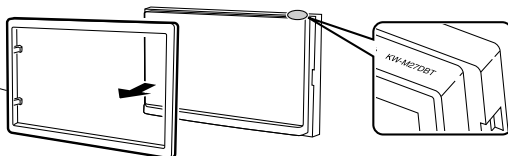

Contents

Before use	2
How to read this manual	2
Precautions	2
Getting Started	3
Clock settings	3
Basics	4
Functions of the Buttons on the Front Panel	4
Common operations	4
HOME screen	4
Source control screen	4
Digital Radio	5
Digital Radio Basic Operation	5
Digital Radio Setup	5
Tuner	6
Tuner Basic Operation	6
Tuner Setup	6
USB	7
Preparation	7
Playback operations	7
iPod/iPhone	8
Preparation	8
Playback operations	8
External Components	9
Using external audio/video players	9
Rear view camera	9
Controlling Audio	9
Controlling General Audio	9
Bluetooth	10
Register your smartphone to the unit	10
Receive a phone call	10
Make a phone call	10
Playing Bluetooth Audio Device	11
Installation	11
Before Installation	11
Installing the unit	12
About this Unit	16
More information	16
Note for specifications	16
Copyrights	16

- For detailed operations and information, refer to the INSTRUCTION MANUAL on the following website:

<<https://www.jvc.net/cs/car/>>



How to read this manual

- The panels shown in this guide are examples used to provide clear explanations of the operations. For this reason, they may be different from the actual panels.
- In operation procedures, bracket shape indicates the key or button you should control.
 - < >: indicates the name of panel buttons.
 - []: indicates the name of touch keys

Before use

Precautions

▲WARNING

■ To prevent injury or fire, take the following precautions:

- To prevent a short circuit, never put or leave any metallic objects (such as coins or metal tools) inside the unit.
- Do not watch or fix your eyes on the unit's display when you are driving for any extended period.
- If you experience problems during installation, consult your JVC dealer.

■ Precautions on using this unit

- When you purchase optional accessories, check with your JVC dealer to make sure that they work with your model and in your area.
- The Radio Data System or Radio Broadcast Data System feature won't work where the service is not supported by any broadcasting station.

■ Protecting the monitor

- To protect the monitor from damage, do not operate the monitor using a ballpoint pen or similar tool with the sharp tip.

■ Cleaning the Unit

If the front panel of this unit is stained, wipe it with a dry soft cloth such as a silicon cloth. If the front panel is stained badly, wipe the stain off with a cloth moistened with neutral cleaner, then wipe it again with a clean soft dry cloth.

▲CAUTION

- Applying spray cleaner directly to the unit may affect its mechanical parts. Wiping the front panel with a hard cloth or using a volatile liquid such as thinner or alcohol may scratch the surface or erase screened print.

■ How to reset your unit

If the unit or the connected unit fails to operate properly, reset the unit.

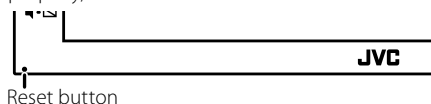

Reset button



This symbol on the product means there are important operating and maintenance instructions in this manual.

Be sure to carefully read instructions in this manual.

Getting Started

1 Turn the ignition key of your car to ACC.

The unit is turned on.

2 Press the < Home > button.

3 Touch [Settings].



4 Touch the corresponding key and set the value.

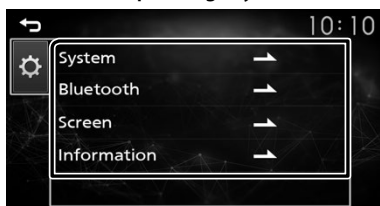

[System]

[Beep Tone]

Activates or deactivates the key-touch tone.
"ON" (Default), "OFF"

[Language]

Select the language used for the control screen and setting items. Default is "English".

[Time/Date]

Adjust the clock time. **(P.3)**

[Clock Mode]

Select the time display format.
[12hr] / [24hr] (Default)

[Parking Guidelines]

You can display parking guidelines to enable easier parking when you shift the gear to the reverse (R) position. Default is "ON".

[Guidelines SETUP]

If you select [ON] for [Parking Guidelines], you can adjust the parking guidelines.

[System Reset]

Touch [System Reset] and then touch [YES] to set all the settings to the initial default settings.

[Bluetooth]

Displays the Bluetooth Settings screen.

[Screen]

[Dimmer]

Select the dimmer mode.
"High" (Default) / "Mid" / "Low"

[Demo]

Select the demonstration mode. Default is "ON".

[Information]

Displays the software version of this unit.

5 Touch [Right Arrow].

Clock settings

■ Synchronizing the clock time with FM RDS

Activate [RDS Clock Sync].
See **Tuner Setup (P.6)**.

■ Adjusting the clock manually

📎 NOTE

- Deactivate [RDS Clock Sync] before adjusting the clock.

1 Press the < Home > button.

2 Touch [Settings].

3 Touch [System].

4 Touch [Time/Date].

Clock screen appears.

5 Touch [▲] or [▼] to set the clock time.



6 Touch [Right Arrow].

Basics

Functions of the Buttons on the Front Panel

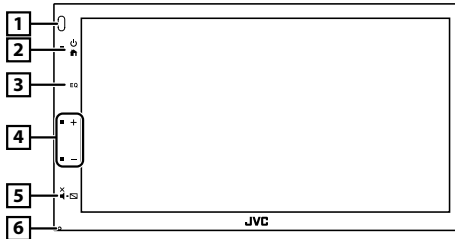

1 Remote Sensor

- Receives the remote control signal.

2 (HOME)

- Displays the HOME screen. **(P.4)**
- Pressing for 1 second turns the power off.
- When the power off, turns the power on.

3 EQ

- Displays the Audio screen.* **(P.9)**
- * The Audio screen is not displayed during SETUP screen or on the list screen etc.

4 +, - (Volume)

- Adjusts volume. The volume will go up until 20 when you keep pressing [+].

5 (MUTE, Display off)

- Mutes/restores the sound.
- Pressing for 1 second turns the screen off.
- When the screen is off, touch the display to turn on the screen.

6 Reset

- If the unit or the connected unit fails to operate properly, the unit returns to factory settings when this button is pressed.

Common operations

Turning on the power

1 Press the button.



Turning off the power

1 Press and hold the button.

HOME screen

1 Press the button.

HOME screen appears.



1 Clock display

2 Switches to the Tuner broadcast. **(P.6)**

3 [USB]

Plays files on a USB device. **(P.7)**

[iPod]

Plays an iPod/iPhone. **(P.8)**

- When iPod/iPhone is connected.

[Mirroring]

Displays the Mirroring screen.

- When android device with "Mirroring OB for JVC" application installed is connected.

4 Switches to an external component connected to the AV-IN input terminal. **(P.9)**

5 Displays the Hands Free screen. **(P.10)**

6 Plays a Bluetooth audio player. **(P.11)**

7 Switches to the digital radio broadcast. **(P.5)**

8 Displays the SETUP screen. **(P.3)**

Source control screen



1 : Returns to previous screen.

: Displays the Audio screen. **(P.9)**

Digital Radio

Digital Radio Basic Operation

- 1 Press the button.
- 2 Touch [Digital Radio].

Source control screen

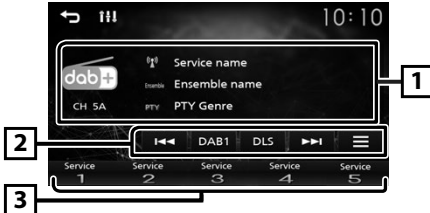

- 1 Displays the information of the current service:
Service name, Ensemble name, PTY Genre, Channel
- 2 **[DAB]**: Switches the Digital Radio preset band. "DAB1", "DAB2", "DAB3"
[DLS]: Display the Dynamic Label Segment screen
**[**: Select an ensemble, service, and component.
[: Displays the Digital Radio Setup screen. **(P.5)**
- 3 Recalls the memorized service.
When touched for 2 seconds, stores the current receiving service in memory.

Store a services

You can store the current receiving service in memory.

- 1 Tune in to a service you want to preset.
 - 2 Touch and hold [#] (#:1-5) in which you want to store the service.
- Select a stored service**
- 1 Touch [#] (#:1-5).

Digital Radio Setup

- 1 Touch [].
- 2 Set each item as follows.



[Service List]

Displays the Service List screen.

- []: Touch and then touch [Yes] to find the latest service list.

[TI]

Switches to the traffic information automatically when the traffic bulletin starts.

"ON", "OFF" (Default)

[PTY]

Searches for a program by program type.

[Priority]

If the same service is provided by Radio Data System when reception of the service being provided by Digital Radio becomes poor, automatically switches to Radio Data System.

"ON", "OFF" (Default)

[Announcement Select]

Switches to the set Announcement service.

[Related Service]

When you select ON, the unit switches to a related service (if exists) when a DAB service network is not available. Default is "OFF".

[Antenna Power]

Sets power supply to the Digital Radio antenna. Set to "ON" when the Digital Radio antenna in use is equipped with a booster. Default is "ON".

- 3 Touch [].

Tuner

Tuner Basic Operation

- 1 Press the <🏠> button.
- 2 Touch [Tuner].

Source control screen

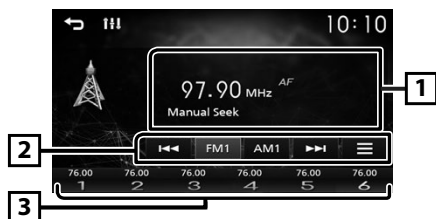

- 1 Displays the information of the current station:
PS name, Frequency, PTY Genre, Indicator Items
- 2 **[FM]**: Switches the FM band.
"FM1", "FM2", "FM3"
[AM]: Switches the AM band.
"AM1", "AM2"
[◀▶]: Tunes in a station with good reception automatically.
[☰]: Displays the Tuner Setup screen. **(P.6)**
- 3 Recalls the memorized station.
When touched for 2 seconds, stores the current receiving station in memory.

Auto memory

You can preset 6 stations for the current band (FM1/FM2/FM3/AM1/AM2).

1 Touch **[FM]** or **[AM]** to select the band.

2 Touch **[☰]**.

3 Touch **[Auto Store]**.

The local stations with the strongest signals are found and stored automatically.

Manual memory

You can store the current receiving station in memory.

1 Tune in to a station you want to preset.

2 Touch and hold **[#]** (#:1-6) in which you want to store the station.

Recalling the preset station

1 Touch **[#]** (#:1-6).

Tuner Setup

- 1 Touch **[☰]**.
- 2 Set each item as follows.

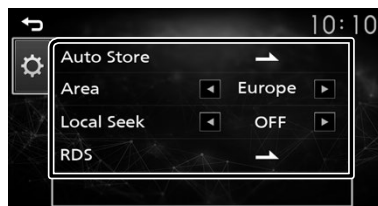

[Auto Store]

Automatically searches and stores the 6 stations with the strongest signals for the selected band.

"Auto Store" appears.

[Local Seek]

Tunes in only to the stations with sufficient signal strength. (**LOC** indicator lights up.)

"ON", "OFF" (Default)

[RDS] *1

Displays the RDS Settings screen.

[AF]

When station reception is poor, automatically switches to the station that is broadcasting the same program over the same Radio Data System network.

"ON" (Default), "OFF"

[TA]

Switches to the traffic information automatically when the traffic bulletin starts. (**TI** indicator lights up.)

"ON", "OFF" (Default)

[RDS Clock Sync]

Synchronizing the Radio Data System station time data and this unit's clock.

"ON" (Default), "OFF"

[PTY]

Select a program type.

[PTY Seek]

Searches for a program by program type.

*1 FM only

3 Touch **[↶]**.

USB

Preparation

■ Connecting a USB device

- 1 Remove the cap of the USB terminal.
- 2 Connect the USB device with the USB cable.

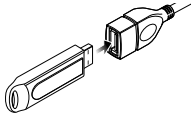

The unit reads the device and playback starts.

■ To disconnect the USB device:

- 1 Press the <⏮> button.
- 2 Touch a source other than [USB].
- 3 Detach the USB device.

■ Usable USB device

This unit can play MPEG1/ MPEG2/ MPEG4/ H.264/ MKV/ MP3/WMA/ AAC/ WAV/ FLAC/ OGG files stored in a USB mass storage class device.

Playback operations

■ Control the music you are listening to on the source control screen.



- 1 The jacket of the currently playing file is displayed.
- 2 Displays the information of the current file.
- 3 Playing time/File number
Play time bar : For confirmation of current playing position.
- 4 [⏮]: Selects Random playback mode.
[⏪]: Selects Repeat playback mode.
[▶], [⏸]: Plays or pauses.
[◀◀], [▶▶]: Searches the previous/next content.
Touch and hold to fast forward or fast backward.
[Q]: Searches file. (P.7)

■ For Video playback

- 1 When the operation buttons are not displayed on the screen, touch the display.

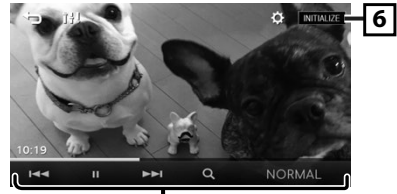

- 6 [⚙️]: You can adjust image quality in video screen.
[INITIALIZE]: To clear the adjustment.
- 7 [▶], [⏸]: Plays or pauses.
[◀◀], [▶▶]: Searches the previous/next content.
Touch and hold to fast forward or fast backward.
[Q]: Searches file. (P.7)
[NORMAL]/[16:9]/[4:3]: Select a screen mode.

■ Selecting a track in a list (Searches file)

- 1 Touch [Q].
- 2 Select whether you search by audio files [🎵], video files [📺].
- 3 Touch [⏮] to moves to the upper hierarchy.
- 4 Touch the desired folder.
When you touch a folder its contents are displayed.
• Touch [⏮] to moves to the upper hierarchy.
- 5 Touch desired item from the content list.
Playback starts.

📎 NOTE

- The source control screen appears when you touch [⏮] at the top hierarchy.

iPod/iPhone

Preparation

■ Connecting iPod/iPhone

- For Lightning connector models: Use USB Audio cable for iPod/iPhone—KS-U62 (optional accessory).
- For details about connecting iPod/iPhone, see page 15 .

1 Remove the cap of the USB terminal.

2 Connect the iPod/iPhone.

The unit reads the device and playback starts.

■ To disconnect the iPod/iPhone

1 Press the <[Home]> button.

2 Touch a source other than [iPod].

3 Detach the iPod/iPhone.

■ Connectable iPod/iPhone

The following models can be connected to this unit.

Made for

- | | | |
|------------------------------|---------------------|------------------|
| • iPhone 12 Pro Max | • iPhone 11 Pro Max | • iPhone 8 Plus |
| • iPhone 12 Pro | • iPhone 11 Pro | • iPhone 8 |
| • iPhone 12 | • iPhone 11 | • iPhone 7 Plus |
| • iPhone 12 mini | • iPhone XS Max | • iPhone 7 |
| • iPhone SE (2nd generation) | • iPhone XS | • iPhone SE |
| | • iPhone XR | • iPhone 6s Plus |
| | • iPhone X | • iPhone 6s |
| | | • iPhone 6 Plus |

📎 NOTE

- If you start playback after connecting the iPod, the music that has been played by the iPod is played first.
- Cap the USB terminal whenever not using.

Playback operations

■ Control the music you are listening to on the source control screen.



1 Artwork (Shown if the track contains artwork)

2 Displays the information of the current file.

3 Playing time/File number
Play time bar : For confirmation of current playing position.

4 [⏮] : Selects Random playback mode.

[⏮] : Selects Repeat playback mode.

[▶], [⏸] : Plays or pauses.

[⏪], [⏩] : Searches the previous/next content.
Touch and hold to fast forward or fast backward.

[🔍] : Searches content. (P.8)

■ Selecting a content in a list

1 Touch [Q].

2 Touch desired item.

When you touch a category its contents are displayed.

3 Touch desired item from the content list.

Playback starts.

- Touch [⏪] to moves to the upper hierarchy.

📎 NOTE

- The source control screen appears when you touch [⏪] at the top hierarchy.

External Components Controlling Audio

Using external audio/video players

Starting playback

- 1 Connect an external component to the AV-IN input terminal. (P.14)
- 2 Press the <⏮> button.
- 3 Touch [AV-IN].
- 4 Turn on the connected component and start playing the source.

For Video playback

- 1 When the operation buttons are not displayed on the screen, touch the display.

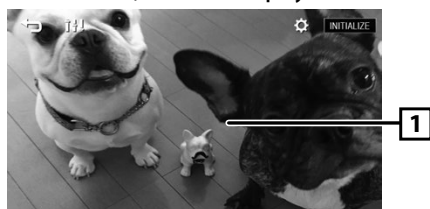

Rear view camera

To use a rear view camera, the REVERSE lead connection is required. For connecting a rear view camera. (P.14)

Displaying the picture from the rear view camera

The rear view screen is displayed when you shift the gear to the reverse (R) position.



- To erase the caution message, touch the screen.

You can adjust various settings such as audio balance or subwoofer level.

- 1 Press the <EQ> button.
- 2 See the below for each operation method.

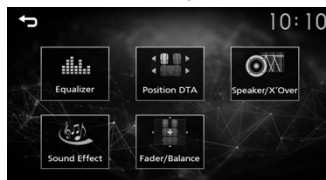

Controlling General Audio

- 1 Press the <EQ> button.
- 2 Touch [Fader / Balance].
- 3 Set each item as follows.



[Fader Balance]

- | | |
|---------------------|---|
| Balance | Adjust the left and right volume balance. |
| [▶] [◀] | 15 (right) to 15 (left) |
| Fader | Adjust the front and rear volume balance. |
| [▲] [▼] | 15 (front) to 15 (rear) |
| [INITIALIZE] | To clear the adjustment. |

Bluetooth

Register your smartphone to the unit

You can use your Bluetooth smartphone when paired to this unit.

- 1 Turn on the Bluetooth function on your smartphone/cell-phone.
- 2 Search the unit ("KW-M27DBT") from your smartphone/cell-phone.
 - If a PIN code is required, enter the PIN code ("0000").
 -  appears when the Bluetooth smartphone is connected.

Disconnecting the device

- Turn off the Bluetooth function from your smartphone/cell-phone.
- Turn off the ignition switch.

Receive a phone call

- 1 Touch .

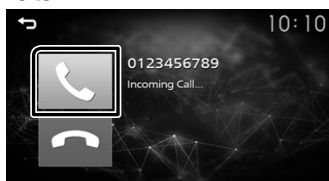

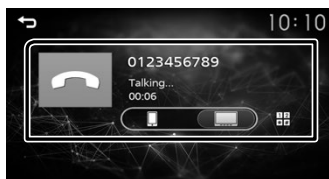

- : Reject an incoming call.

Operations during a call



-  Ending a call

-  You can send tones by touching desired keys on the screen.
 - Touch  to close the window.

-  Switches the speaking voice output between smartphone/cell-phone and speaker.

- Adjust the receiver volume
Press the < + > or < - > button.

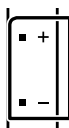



Make a phone call

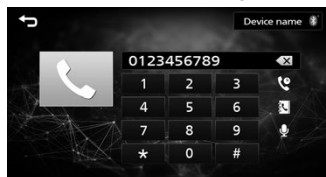



- 1 Press the  button.
- 2 Touch [Phone].
- 3 See the table below for each operation method.





Call by entering a phone number

- 1) Enter a phone number with number keys.
- 2) Touch .
 - Make a call
 - Touch  to delete the last entry.

Call using call records

- 1) Touch .
- 2) Touch  (Incoming Calls),  (Outgoing Calls),  (Missed Calls).
- 3) Select the phone number from the list.
 - Make a call

Call using the phonebook

- 1) Touch .
- 2) Select the name from the list.
 - Make a call
 - : Updates the phonebook. Touch this button after you have made a change to the phonebook of your smartphone/cell-phone.

Bluetooth

Playing Bluetooth Audio Device

1 Press the button.

2 Touch [BT Audio].

Source control screen



1 Displays the information of the current file.

2 Playing time/File number

Play time bar : For confirmation of current playing position.

3  : Selects Random playback mode.

 : Selects Repeat playback mode.

,  : Plays or pauses.

,  : Searches the previous/next content.

Touch and hold to fast forward or fast backward.

 : Searches file. **(P.11)**

NOTE

- Operations and display indications may differ according to their availability on the connected device.

Selecting a content in a list

1 Touch [Q].

2 Touch desired item.

When you touch a category its contents are displayed.

3 Touch desired item from the content list.

Playback starts.

- Touch  to moves to the upper hierarchy.

NOTE

- The source control screen appears when you touch  at the top hierarchy.

Installation

Before Installation

Before installation of this unit, please note the following precautions.

WARNINGS

- If you connect the ignition wire (red) and the battery wire (yellow) to the car chassis (ground), you may cause a short circuit, that in turn may start a fire. Always connect those wires to the power source running through the fuse box.
- Do not cut out the fuse from the ignition wire (red) and the battery wire (yellow). The power supply must be connected to the wires via the fuse.

CAUTION

- Install this unit in the console of your vehicle. Do not touch the metal part of this unit during and shortly after the use of the unit. Metal part such as the heat sink and enclosure become hot.

NOTE





- Mounting and wiring this product requires skills and experience. For best safety, leave the mounting and wiring work to professionals.
- Make sure to ground the unit to a negative 12V DC power supply.
- Do not install the unit in a spot exposed to direct sunlight or excessive heat or humidity. Also avoid places with too much dust or the possibility of water splashing.
- Do not use your own screws. Use only the screws provided. If you use the wrong screws, you could damage the unit.
- If your car's ignition does not have an ACC position, connect the ignition wires to a power source that can be turned on and off with the ignition key. If you connect the ignition wire to a power source with a constant voltage supply, such as with battery wires, the battery may be drained.
- If the console has a lid, make sure to install the unit so that the front panel will not hit the lid when closing and opening.
- If the fuse blows, first make sure the wires aren't touching to cause a short circuit, then replace the old fuse with one with the same rating.
- Insulate unconnected wires with vinyl tape or other similar material. To prevent a short circuit, do not remove the caps on the ends of the unconnected wires or the terminals.
- Secure the wires with cable clamps and wrap vinyl tape around the wires that comes into contact with metal parts to protect the wires and to prevent short circuit.

Installation

- Connect the speaker wires correctly to the terminals to which they correspond. The unit may be damaged or fail to work if you share the \ominus wires or ground them to any metal part in the car.
- When only two speakers are being connected to the system, connect the connectors either to both the front output terminals or to both the rear output terminals (do not mix front and rear). For example, if you connect the \oplus connector of the left speaker to a front output terminal, do not connect the \ominus connector to a rear output terminal.
- After the unit is installed, check whether the brake lamps, blinkers, wipers, etc. on the car are working properly.
- Mount the unit so that the mounting angle is 30° or less.
- Do not press hard on the panel surface when installing the unit to the vehicle. Otherwise scars, damage, or failure may result.
- Reception may drop if there are metal objects near the Bluetooth antenna.

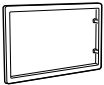

■ Supplied accessories for installation

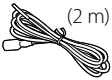
①		x1	②		x2
③		x1	④ (3 m)		x1
⑤		(2 m) x1			

■ Installation procedure

- 1) To prevent a short circuit, remove the key from the ignition and disconnect the \ominus terminal of the battery.
- 2) Make the proper input and output wire connections for each unit.
- 3) Connect the ISO connector to the unit.
- 4) Install the unit in your car.
- 5) Reconnect the \ominus terminal of the battery.
- 6) Press the reset button.

Installing the unit

■ Non-Japanese cars

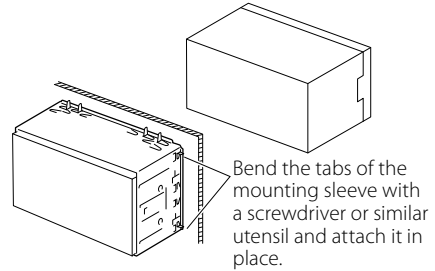

NOTE

- Make sure that the unit is installed securely in place. If the unit is unstable, it may malfunction (eg, the sound may skip).

■ Trim plate

- 1) Attach accessory ① to the unit.

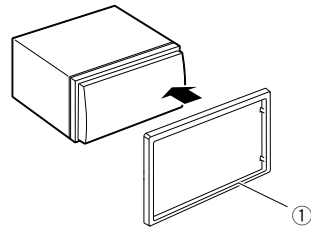

Installation

Microphone unit

- 1) Check the installation position of the microphone (accessory ④).
- 2) Clean the installation surface.
- 3) Remove the separator of the microphone (accessory ④), and stick the microphone to the place shown below.
- 4) Wire the microphone cable up to the unit with it secured at several positions using tape or other desired method.
- 5) Adjust the direction of the microphone (accessory ④) to the driver.

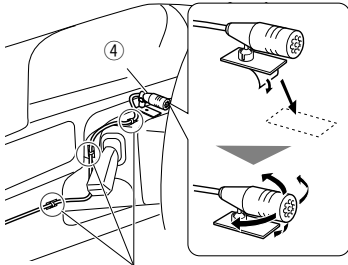

Fix a cable with a commercial item of tape.

NOTE

- Swap the clips if necessary.

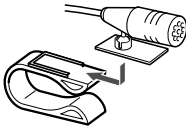

Removing the trim plate

- 1) Use the extraction key (accessory ③) to lever out the four tabs (two on the left part, two on the right part).

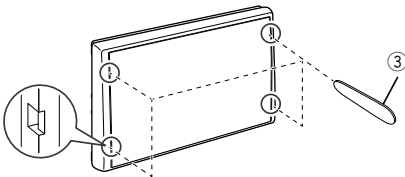

- 2) Pull the trim plate forward.

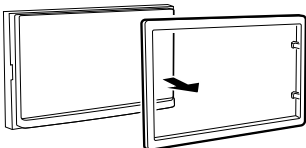

Removing the unit

- 1) Remove the trim plate by referring to step 1 in "Removing the trim plate".
- 2) Insert the extraction key (accessory ②) deeply into the slot as shown. (The protrusion at the tip of the extraction key must face toward the unit.)

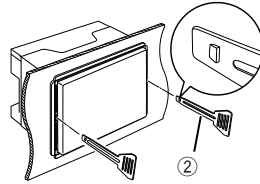

- 3) With the inserted extraction key secured, insert the other extraction key into the slot.

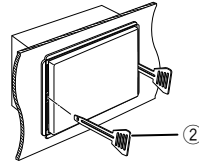

- 4) Pull out the unit halfway.

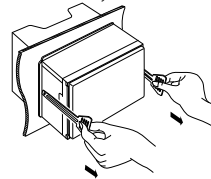

NOTE

- Be careful to avoid injury from the catch pins on the extraction key.
- 5) Pull the unit all the way out with your hands, being careful not to drop it.

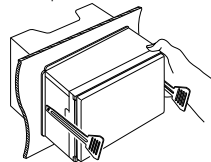

Installation

Connecting wires to terminals

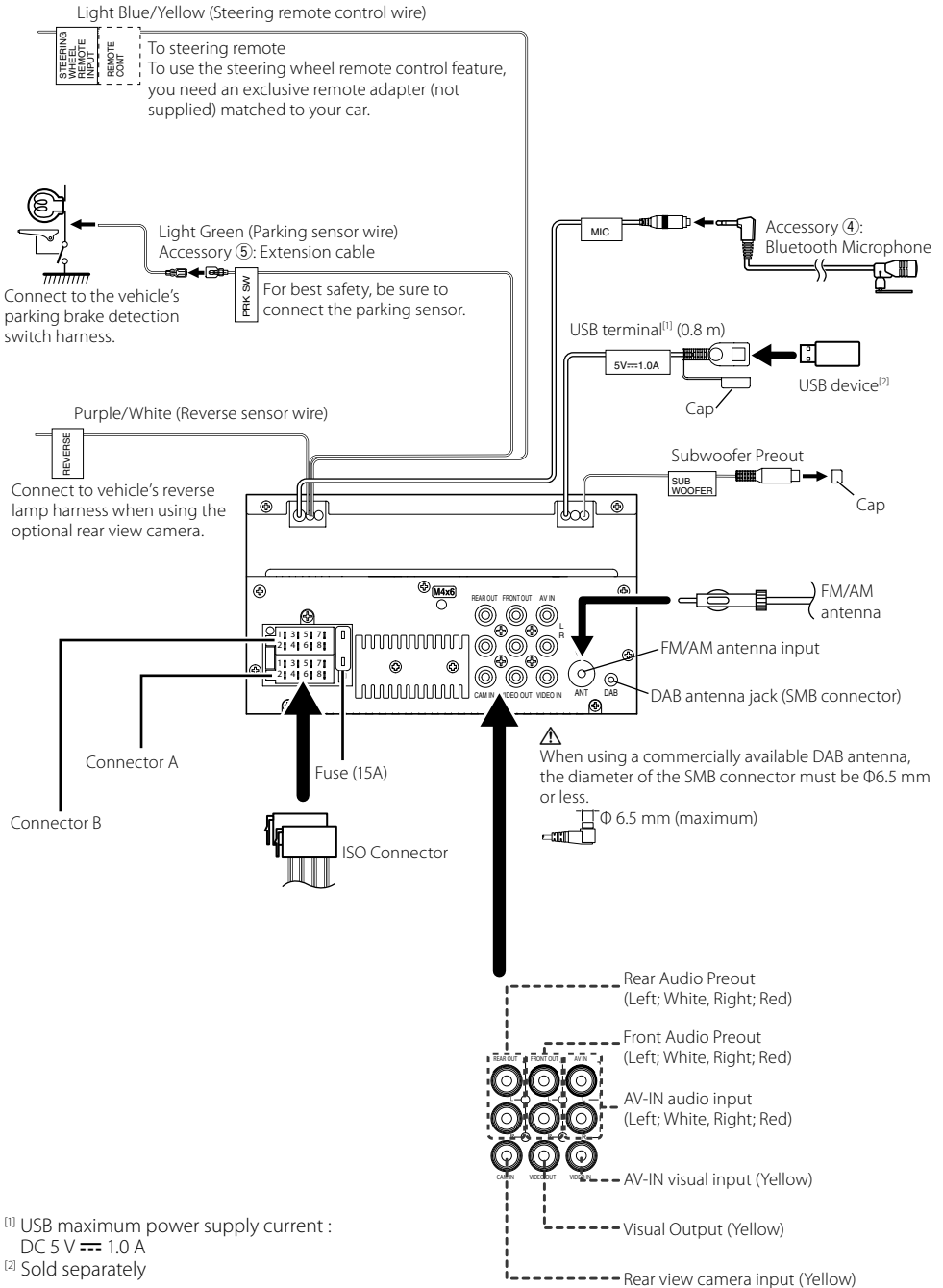

^[1] USB maximum power supply current : DC 5 V = 1.0 A

^[2] Sold separately

Installation

■ Wiring harness connector function guide

Pin	Color and function	
A-4	Yellow	Battery
A-5	Blue/White ^[1]	Power Control
A-7	Red	Ignition (ACC)
A-8	Black	Earth (Ground) Connection
B-1/ B-2	Purple (+) / Purple/Black (-)	Rear Right
B-3/ B-4	Gray (+) / Gray/Black (-)	Front Right
B-5/ B-6	White (+) / White/Black (-)	Front Left
B-7/ B-8	Green (+) / Green/Black (-)	Rear Left

^[1] Max. 150mA, 12V

- Speaker Impedance: 4-8 Ω

⚠ CAUTION

Before you connect the commercially available ISO connectors to the unit, check the following condition:

- Make sure that the pin assignment of the connector matches with the JVC unit.
- Take extra notice of the power wire.
- In case battery wire and ignition wire are not corresponding then change them accordingly.
- In case the car does not have an ignition wire, use a commercially available interface.

■ Connecting an iPod/iPhone/Android

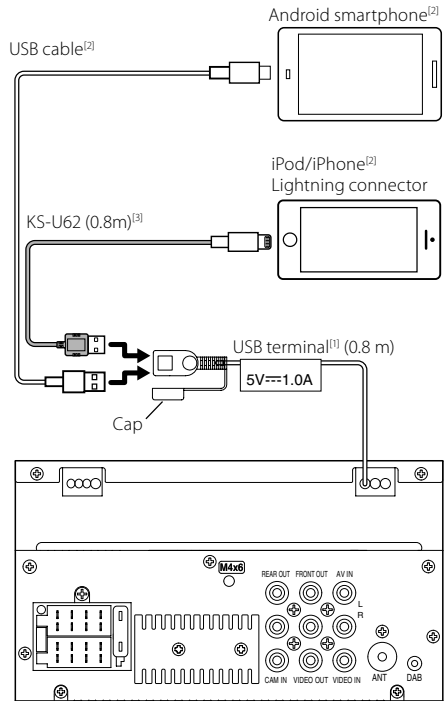

^[1] USB maximum power supply current :

DC 5 V $\overline{\text{---}}$ 1.0 A

^[2] Sold separately

^[3] Optional accessory

About this Unit

More information

Usable USB device

This unit can play MPEG1/ MPEG2/ MPEG4/ H.264/ MKV/ MP3/WMA/ AAC/ WAV/ FLAC/ OGG files stored in a USB mass storage class device.

- File system: FAT16/ FAT32

NOTE

- When the USB device is connected to this unit, it can be charged through the USB cable.
- Install the USB device in the place where it will not affect safe driving.
- You cannot connect a USB device via a USB hub and Multi Card Reader.
- Take backups of the audio files used with this unit. The files may be erased depending on the operating conditions of the USB device. We shall have no compensation for any damage arising from any erased data.
- No USB device comes with this unit. You need to purchase a commercially available USB device.
- Cap the USB terminal whenever not using.

Playable Audio files

Audio format	Extension
MP3	.mp3
WMA	.wma
AAC-LC	.m4a, .aac
Linear PCM (WAVE)	.wav
FLAC	.flac
Vorbis	.ogg

- This unit can show ID3 Tag Version 1.0/1.1/2.2/3/2.4 (for MP3).

NOTE

- WMA and AAC of which is covered with DRM cannot be played.
- Although the audio files are complied with the standards listed above, the play may be impossible depending on the types or conditions of media or device.

Acceptable Video files

Video format	Extension
MPEG-1	.mpg, .mpeg
MPEG-2	.mpg, .mpeg
MPEG-4	.mp4, .avi
H.264/MPEG-4 AVC	.mp4, .mkv, .avi, .flv, .f4v, .ts
MKV	.mkv

Note for specifications

Bluetooth section

Frequency
: 2.402 – 2.480 GHz

Output Power
: +8 dBm (AVE), Power Class1

General

Speaker Impedance
: 4 – 8 Ω

Operating Voltage
: 12 V DC car battery

Copyrights

- The Bluetooth word mark and logos are registered trademarks owned by the Bluetooth SIG, Inc. and any use of such marks by JVCKENWOOD Corporation is under license. Other trademarks and trade names are those of their respective owners.
- Use of the Made for Apple badge means that an accessory has been designed to connect specifically to the Apple product(s) identified in the badge and has been certified by the developer to meet Apple performance standards. Apple is not responsible for the operation of this device or its compliance with safety and regulatory standards. Please note that the use of this accessory with an Apple product may affect wireless performance.
- Apple, iPhone, iPod, iPod touch, and Lightning are trademarks of Apple Inc., registered in the U.S. and other countries.
- Microsoft and Windows Media are either registered trademarks or trademarks of Microsoft Corporation in the United States and/or other countries.
- THIS PRODUCT IS LICENSED UNDER THE MPEG-4 VISUAL PATENT PORTFOLIO LICENSE FOR THE PERSONAL AND NON-COMMERCIAL USE OF A CONSUMER FOR (i) ENCODING VIDEO IN COMPLIANCE WITH THE MPEG-4 VISUAL STANDARD ("MPEG-4 VIDEO") AND/OR (ii) DECODING MPEG-4 VIDEO THAT WAS ENCODED BY A CONSUMER ENGAGED IN A PERSONAL AND NON-COMMERCIAL ACTIVITY AND/OR WAS OBTAINED FROM A VIDEO PROVIDER LICENSED BY MPEG LA TO PROVIDE MPEG-4 VIDEO. NO LICENSE IS GRANTED OR SHALL BE IMPLIED FOR ANY OTHER USE. ADDITIONAL INFORMATION INCLUDING THAT RELATING TO PROMOTIONAL, INTERNAL AND COMMERCIAL USES AND LICENSING MAY BE OBTAINED FROM MPEG LA, LLC. SEE [HTTP://WWW.MPEGLA.COM](http://www.mpegla.com).
- THIS PRODUCT IS LICENSED UNDER THE AVC PATENT PORTFOLIO LICENSE FOR THE PERSONAL USE OF A CONSUMER OR OTHER USES IN WHICH IT DOES NOT RECEIVE REMUNERATION TO (i) ENCODE VIDEO IN COMPLIANCE WITH THE AVC STANDARD ("AVC VIDEO") AND/OR (ii) DECODE AVC VIDEO THAT WAS ENCODED BY

About this Unit

A CONSUMER ENGAGED IN A PERSONAL ACTIVITY AND/OR WAS OBTAINED FROM A VIDEO PROVIDER LICENSED TO PROVIDE AVC VIDEO. NO LICENSE IS GRANTED OR SHALL BE IMPLIED FOR ANY OTHER USE. ADDITIONAL INFORMATION MAY BE OBTAINED FROM MPEG LA, L.L.C. SEE [HTTP://WWW.MPEGLA.COM](http://www.mpegla.com)

• libFLAC

Copyright (C) 2000-2009 Josh Coalsou

Copyright (C) 2011-2013 Xiph.Org Foundation

– Redistribution and use in source and binary forms, with or without modification, are permitted provided that the following conditions are met:

– Redistributions of source code must retain the above copyright notice, this list of conditions and the following disclaimer.

– Redistributions in binary form must reproduce the above copyright notice, this list of conditions and the following disclaimer in the documentation and/or other materials provided with the distribution.

Neither the name of the Xiph.org Foundation nor the names of its contributors may be used to endorse or promote products derived from this software without specific prior written permission.

THIS SOFTWARE IS PROVIDED BY THE COPYRIGHT HOLDERS AND CONTRIBUTORS "AS IS" AND ANY EXPRESS OR IMPLIED WARRANTIES, INCLUDING, BUT NOT LIMITED TO, THE IMPLIED WARRANTIES OF MERCHANTABILITY AND FITNESS FOR A PARTICULAR PURPOSE ARE DISCLAIMED. IN NO EVENT SHALL THE FOUNDATION OR CONTRIBUTORS BE LIABLE FOR ANY DIRECT, INDIRECT, INCIDENTAL, SPECIAL, EXEMPLARY, OR CONSEQUENTIAL DAMAGES (INCLUDING, BUT NOT LIMITED TO, PROCUREMENT OF SUBSTITUTE GOODS OR SERVICES; LOSS OF USE, DATA, OR PROFITS; OR BUSINESS INTERRUPTION) HOWEVER CAUSED AND ON ANY THEORY OF LIABILITY, WHETHER IN CONTRACT, STRICT LIABILITY, OR TORT (INCLUDING NEGLIGENCE OR OTHERWISE) ARISING IN ANY WAY OUT OF THE USE OF THIS SOFTWARE, EVEN IF ADVISED OF THE POSSIBILITY OF SUCH DAMAGE.

• libogg

Copyright (c) 2002, Xiph.org Foundation Redistribution and use in source and binary forms, with or without modification, are permitted provided that the following conditions are met:

– Redistributions of source code must retain the above copyright notice, this list of conditions and the following disclaimer.

– Redistributions in binary form must reproduce the above copyright notice, this list of conditions and the following disclaimer in the documentation and/or other materials provided with the distribution.

– Neither the name of the Xiph.org Foundation nor the names of its contributors may be used to endorse or promote products derived from this software without specific prior written permission.

THIS SOFTWARE IS PROVIDED BY THE COPYRIGHT HOLDERS AND CONTRIBUTORS "AS IS" AND ANY EXPRESS OR IMPLIED WARRANTIES, INCLUDING, BUT NOT LIMITED TO, THE IMPLIED WARRANTIES OF MERCHANTABILITY AND FITNESS FOR A PARTICULAR PURPOSE ARE DISCLAIMED. IN NO EVENT SHALL THE FOUNDATION OR CONTRIBUTORS BE LIABLE FOR ANY DIRECT, INDIRECT, INCIDENTAL, SPECIAL, EXEMPLARY, OR CONSEQUENTIAL DAMAGES (INCLUDING, BUT NOT LIMITED TO, PROCUREMENT OF SUBSTITUTE GOODS OR SERVICES; LOSS OF USE, DATA, OR PROFITS; OR BUSINESS INTERRUPTION) HOWEVER CAUSED AND ON ANY THEORY OF LIABILITY, WHETHER IN CONTRACT, STRICT LIABILITY, OR TORT (INCLUDING NEGLIGENCE OR OTHERWISE) ARISING IN ANY WAY OUT OF THE USE OF THIS SOFTWARE, EVEN IF ADVISED OF THE POSSIBILITY OF SUCH DAMAGE.

■ Information on Disposal of Old Electrical and Electronic Equipment and Batteries (applicable for EU countries that have adopted separate waste collection systems)

Products and batteries with the symbol (crossed-out wheeled bin) cannot be disposed as household waste. Old electrical and electronic equipment and batteries should be recycled at a facility capable of handling these items and their waste byproducts.

Contact your local authority for details in locating a recycle facility nearest to you.

Proper recycling and waste disposal will help conserve resources whilst preventing detrimental effects on our health and the environment.

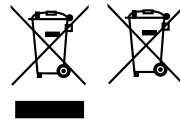

For Israel

■ מידע בדבר השלכה לאשפה של ציוד חשמלי ואלקטרוני ישן וכן סוללות (רלוונטי למדינות שמשתמשות במערכת איסוף אשפה מופרדת).

לא ניתן להשליך מוצרים וסוללות עם הסימון (פח אשפה עם X עליו) כאשפה ביתית רגילה.

יש למחזר ציוד חשמלי ואלקטרוני ישן וכן סוללות במתקן המסוגל לטפל בפריטים כאלה ובתוצרי הלואי שלהם.

צרו קשר עם הרשות המקומית לקבלת פריטים אודות מתקן המיחזור הקרוב אליכם. מיחזור והשלכה לאשפה נאותים יעזרו לשמר משאבים ולמנוע השפעות שליליות על בריאותנו ועל הסביבה.

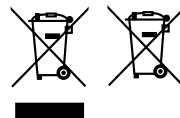

Table des matières

Avant l'utilisation	18
Comment lire ce manuel	18
Précautions	18
Mise en route.....	19
Paramètres de l'horloge.....	19
Les bases	20
Fonctions des boutons en façade.....	20
Opérations courantes.....	20
Écran d'ACCUEIL.....	20
Écran de commande de source	20
Radio numérique.....	21
Utilisation de base de la radio numérique.....	21
Configuration de la radio numérique.....	21
Tuner.....	22
Utilisation de base de la radio.....	22
Configuration du syntoniseur.....	22
USB	23
Préparation.....	23
Options de lecture.....	23
iPod/iPhone.....	24
Préparation.....	24
Options de lecture.....	24
Composants Externes.....	25
Utilisant des lecteurs audio/vidéo externes.....	25
Caméra de recul.....	25
Contrôle de l'audio.....	25
Contrôle de l'audio en général.....	25
Bluetooth	26
Enregistrer votre smartphone dans l'appareil.....	26
Recevoir un appel.....	26
Passer un appel.....	26
Utilisation d'un appareil audio Bluetooth en lecture.....	27
Installation.....	27
Avant l'installation.....	27
Installation de l'appareil.....	28
À propos de cet appareil.....	32
Plus d'informations.....	32
Remarques concernant les spécifications.....	32
Copyrights.....	32

- En ce qui concerne les opérations et les informations détaillées, se reporter au MODE D'EMPLOI sur le site Web suivant :

<<https://www.jvc.net/cs/car/>>



Comment lire ce manuel

- Les écrans illustrés dans le présent guide sont des exemples destinés à fournir des explications plus claires des opérations. Pour cette raison, il peut arriver qu'ils soient différents de ceux rencontrés dans la réalité.
- Dans les procédures opérationnelles, le crochet indique la touche ou le bouton à activer.
 - < >: Indique le nom des boutons du panneau.
 - []: indique le nom des touches tactiles.

Avant l'utilisation

Précautions

▲ AVERTISSEMENT

■ Pour éviter toute blessure ou incendie, prenez les précautions suivantes :

- Pour éviter un court-circuit, ne mettez ni ne laissez jamais d'objets métalliques (comme des pièces de monnaie ou des outils en métal) à l'intérieur de l'appareil.
- Ne regardez pas ni ne fixez votre regard sur l'affichage de l'appareil trop longtemps pendant la conduite.
- Si vous rencontrez des problèmes pendant l'installation, consultez votre revendeur JVC.

■ Précautions d'utilisation de l'appareil

- Lorsque vous achetez des accessoires en option, vérifiez auprès de votre revendeur JVC qu'ils fonctionneront avec votre modèle et dans votre région.
- Les fonctions Radio Data System ou Radio Broadcast Data System sont inopérantes dans les zones où le service n'est pris en charge par aucune station de radiodiffusion.

■ Protection du moniteur

- Ne touchez pas le moniteur avec un stylo à bille ou tout autre outil pointu. Cela pourrait l'endommager.

■ Nettoyage de l'appareil

Si la façade de l'appareil est tachée, essuyez-la avec un chiffon doux et sec, tel qu'un chiffon siliconé. Si la façade est très sale, essuyez-la avec un chiffon imbibé d'un produit de nettoyage neutre, puis essuyez-la à nouveau avec un chiffon doux et sec propre.

▲ ATTENTION

- La pulvérisation directe de produit de nettoyage sur l'appareil risque d'endommager les pièces mécaniques. Si vous nettoyez la façade avec un chiffon trop rugueux ou un liquide volatil, comme un solvant ou de l'alcool, vous risquez d'en rayer la surface ou d'effacer les caractères sérigraphiés.

■ Comment réinitialiser votre appareil

Si l'appareil ou l'équipement qui lui est branché ne fonctionne pas normalement, réinitialisez-le.

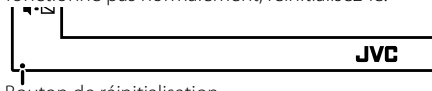

Bouton de réinitialisation



Ce symbole sur le produit indique que ce mode d'emploi contient d'importantes instructions d'utilisation et d'entretien. Assurez-vous de lire attentivement les instructions de ce manuel.

Mise en route

1 Tournez la clé de contact de votre véhicule sur la position ACC.

L'appareil se met en marche.

2 Appuyez sur le bouton <🏠>.

3 Touchez [⚙️].

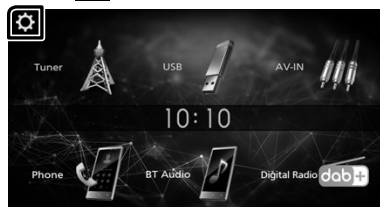

4 Effleurez la touche correspondante, puis définissez la valeur.



[System]

[Beep Tone]

Active ou désactive la touche ton.
« ON » (par défaut), « OFF »

[Language]

Sélectionne la langue utilisée sur l'écran de commande et sur les éléments de configuration. La langue sélectionnée par défaut est « English » (anglais).

[Time/Date]

Réglez l'heure de l'horloge. (p.19)

[Clock Mode]

Sélectionnez le format d'affichage de l'heure.
[12hr] / [24hr] (par défaut)

[Parking Guidelines]

Vous pouvez afficher les directives de stationnement pour faciliter le stationnement lorsque vous changez le rapport dans la position marche arrière (AR). Le choix par défaut est « ON ».

[Guidelines SETUP]

Si vous sélectionnez [ON] pour [Parking Guidelines], vous pouvez ajuster les instructions de parking.

[System Reset]

Touchez [System Reset] puis touchez [YES] pour ramener tous les réglages aux réglages initiaux par défaut.

[Bluetooth]

Affiche l'écran de réglages du Bluetooth.

[Screen]

[Dimmer]

Sélectionner le mode gradateur.
« High » (par défaut) / « Mid » / « Low »

[Demo]

Sélectionner le mode démonstration. Le choix par défaut est « ON ».

[Information]

Affiche la version du logiciel de cet appareil.

5 Touchez [↩️].

Paramètres de l'horloge

■ Synchronisation de l'heure avec FM RDS

Activer [RDS Clock Sync] (Synchronisation de l'heure RDS).

Voir *Configuration du syntoniseur (p.22)*.

■ Ajuster l'horloge manuellement

🔧 REMARQUE

- Désactivez [RDS Clock Sync] avant de régler l'horloge.

1 Appuyez sur le bouton <🏠>.

2 Touchez [⚙️].

3 Touchez [System].

4 Touchez [Time/Date].

L'écran de l'heure s'affiche.

5 Touchez [▲] ou [▼] pour régler l'heure de l'horloge.



6 Touchez [↩️].

Les bases

Fonctions des boutons en façade

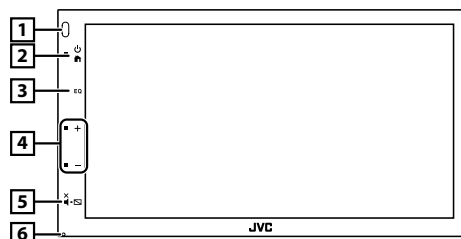

1 Capteur à distance

- Reçoit le signal de la télécommande.

2 (HOME)

- Affiche l'écran d'ACCUEIL. (p.20)
- Appuyez pendant 1 seconde pour éteindre l'appareil.
- Quand l'appareil est éteint, permet de le mettre en marche.

3 EQ

- Affiche l'écran audio.* (p.25)
- * L'écran Audio ne s'affiche pas sur l'écran de configuration ni sur l'écran de la liste, etc.

4 +, - (Volume)

- Règle le volume. Le volume augmentera jusqu'à 20 tant que vous maintiendrez [+] enfoncé.

5 (MUTE, Display off)

- Met sur muet/restaure le son.
- Appuyez pendant 1 seconde pour éteindre l'écran.
- Lorsque l'écran est éteint, appuyez sur l'affichage pour activer l'écran.

6 Réinitialisation

- Si l'appareil ou l'appareil qui y est connecté ne fonctionne pas correctement, appuyez sur ce bouton pour que l'appareil retrouve les réglages d'usine.

Opérations courantes

Allumer le courant

1 Appuyez sur le bouton .



Éteindre le courant

1 Appuyez et maintenez enfoncé le bouton



Écran d'ACCUEIL

1 Appuyez sur le bouton .

L'écran d'ACCUEIL apparaît.

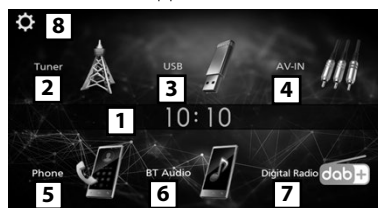

1 Affichage de l'horloge

2 Passe à l'émission de radio. (p.22)

3 [USB]

Joue les fichiers d'un périphérique USB. (p.23)

[iPod]

Joue depuis un iPod/iPhone. (p.24)
• Lorsqu'un iPod/iPhone est connecté.

[Mirroring]

Affiche l'écran de reflet.
• Lorsqu'un appareil Android avec l'application « Mirroring OB for JVC » installée est connecté.

4 Passe à un élément externe connecté à la borne d'entrée AV-IN. (p.25)

5 Affiche l'écran Mains libres. (p.26)

6 Lit les fichiers sur un lecteur audio Bluetooth. (p.27)

7 Passe à l'émission de radio numérique. (p.21)

8 Affiche l'écran de CONFIGURATION. (p.19)

Écran de commande de source



1 [] : Revient à l'écran précédent.

[] : Affiche l'écran audio. (p.25)

Radio numérique

Utilisation de base de la radio numérique

1 Appuyez sur le bouton <🏠>.

2 Touchez [Digital Radio].

■ Écran de commande de source



1 Affiche les informations concernant le service en cours :

Nom du service, nom de l'ensemble, genre PTY, canal

2 **[DAB]** : Bascule la bande pré-réglée de la radio numérique.

« DAB1 », « DAB2 », « DAB3 »

[DLS] : Afficher l'écran de segment d'Étiquette Dynamique

[<<|>>] : Sélectionner un ensemble, un service et un composant.

[☰] : Affiche l'écran de réglages de la radio numérique. (p.21)

3 Rappelle le service mémorisé.

En le touchant pendant 2 secondes, il mémorise le service en cours de réception.

■ Mémoriser un service

Vous pouvez mémoriser le service que vous êtes en train de recevoir.

1 Rechercher un service que vous voulez présélectionner.

2 Toucher et maintenir [#] (#:1-5) dans lequel vous voulez mémoriser le service.

■ Sélectionner un service mémorisé

1 Toucher [#] (#:1-5).

Configuration de la radio numérique

1 Touchez [☰].

2 Réglez chaque option comme suit.

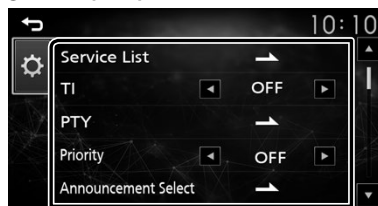

[Service List]

Affiche l'écran de liste des services.

- **[🔍]** : Touchez-le puis touchez [Yes] pour rechercher la liste de services la plus récente.

[TI]

Passer automatiquement aux informations de circulation routière à l'instant ou un bulletin d'infotrafic débute.

« ON », « OFF » (par défaut)

[PTY]

Recherche un programme par type de programme.

[Priority]

Si le même service est fourni par Radio Data System alors que la réception du service Digital Radio s'affaiblit, la sélection se fait automatiquement sur Radio Data System.

« ON », « OFF » (par défaut)

[Announcement Select]

Permet de passer au service d'annonce défini.

[Related Service]

Lorsque vous sélectionnez MARCHÉ, l'appareil commute sur un service semblable (s'il existe) lorsqu'un réseau service DAB n'est pas disponible. Le choix par défaut est « OFF ».

[Antenna Power]

Règle l'alimentation sur l'antenne de la Radio Numérique. Règle sur « ON » lorsque l'antenne de la Radio Numérique en cours d'utilisation est équipée d'un amplificateur. Le choix par défaut est « ON ».

3 Touchez [**↩**].

Tuner

Utilisation de base de la radio

- 1 Appuyez sur le bouton <🏠>.
- 2 Touchez [Tuner].

📺 Écran de commande de source

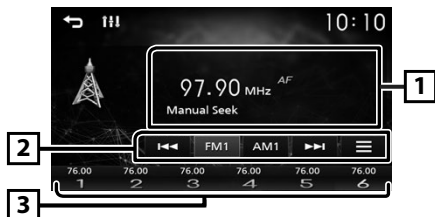

- 1 Affiche les informations concernant la station en cours :
Nom PS, Fréquence, Genre PTY, Indicateur d'articles
- 2 **[FM]** : Change la bande FM.
« FM1 », « FM2 », « FM3 »
[AM] : Change la bande AM.
« AM1 », « AM2 »
[◀▶] : Syntonise automatiquement sur une station offrant une bonne réception.
[☰] : Affiche l'écran de CONFIGURATION du tuner. (p.22)
- 3 Rappelle la station mémorisée.
En le touchant pendant 2 secondes, il mémorise la station en cours de réception.

📺 Mémoire automatique

Vous pouvez présélectionner 6 stations pour la bande actuelle (FM1/FM2/FM3/AM1/AM2).

- 1 Appuyez sur [FM] ou [AM] pour sélectionner la bande.
- 2 Touchez [☰].
- 3 Toucher [Auto Store].
Les stations locales avec les signaux les plus forts sont trouvées et enregistrées automatiquement.

📺 Mémoire manuelle

Vous pouvez mémoriser la station que vous êtes en train de recevoir.

- 1 Rechercher une station que vous voulez présélectionner.
 - 2 Toucher et maintenir [#] (#:1-6) dans lequel vous voulez mémoriser la station.
- 📺 Rappel de la station prédéfinie
- 1 Toucher [#] (#:1-6).

Configuration du syntoniseur

- 1 Touchez [☰].
- 2 Réglez chaque option comme suit.

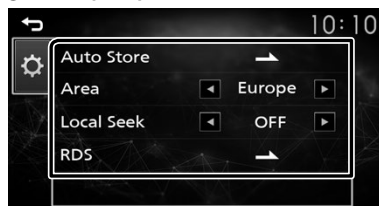

[Auto Store]

Recherche et mémorise automatiquement les 6 stations avec les signaux les plus puissants pour la bande sélectionnée.

« Auto Store » (Mémoriser Automatiquement) apparaît.

[Local Seek]

Recherche uniquement les stations ayant une intensité suffisante de signal. (L'indicateur **LOC** s'allume.)

« ON », « OFF » (par défaut)

[RDS] *1

Affiche l'écran de réglages du RDS.

[AF]

Lorsque la réception de la station est médiocre, sélectionne automatiquement une station diffusant le même programme sur le même réseau Radio Data System.

« ON » (par défaut), « OFF »

[TA]

Passer automatiquement aux informations de circulation routière à l'instant ou un bulletin d'infos-traffic débute. (L'indicateur **TI** s'allume.)

« ON », « OFF » (par défaut)

[RDS Clock Sync]

Synchroniser les données de temps de la station Radio Data System et l'horloge de cet appareil.

« ON » (par défaut), « OFF »

[PTY]

Sélectionner un type de programme.

[PTY Seek]

Recherche un programme par type de programme.

*1 FM uniquement

- 3 Touchez [↶].

USB

Préparation

■ Connecter un périphérique USB

- 1 Retirer le capuchon de la borne USB.
- 2 Branchez le périphérique USB avec le câble USB.

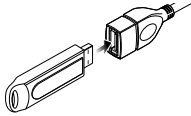

L'appareil lit le périphérique et la lecture commence.

■ Pour débrancher le périphérique USB :

- 1 Appuyez sur le bouton .
- 2 Sélectionner une source autre que [USB].
- 3 Débranchez le périphérique USB.



■ Périphérique USB utilisable

Cet appareil peut lire les fichiers MPEG1/ MPEG2/ MPEG4/ H.264/ MKV/ MP3/WMA/ AAC/ WAV/ FLAC/ OGG stockés dans un périphérique de stockage de masse USB.

Options de lecture

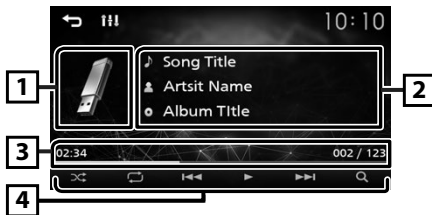
■ L'écran de commande de la source vous permet de gérer la musique que vous écoutez.



- 1 La pochette du fichier en cours de lecture s'affiche.
- 2 Affiche les informations concernant le fichier en cours.
- 3 Temps de lecture/Numéro de fichier
Barre du temps de lecture : Pour confirmer la position actuelle de lecture.
- 4  : Sélectionne le mode de lecture aléatoire.
 : Sélectionne le mode de lecture répétée.
 : Lit ou marque une pause.

[], [>img alt="bouton suivant" data-bbox="585 75 605 95"/>] : Recherche le contenu précédent/suivant.

Touchez et maintenez enfoncé pour effectuer une avance ou un retour rapide.

[Q] : Recherche le fichier. (p.23)

■ Pour la lecture de vidéo

1 Lorsque les touches de fonctionnement ne sont pas affichées à l'écran, toucher l'écran.

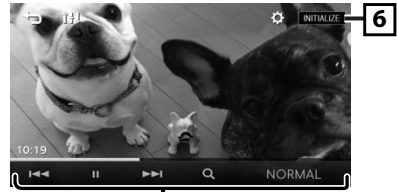

6  : Vous pouvez régler la qualité d'image dans l'écran vidéo.

[INITIALIZE] : Pour effacer le réglage.

7  : Lit ou marque une pause.





[], [>img alt="bouton suivant" data-bbox="585 445 605 465"/>] : Recherche le contenu précédent/suivant.

Touchez et maintenez enfoncé pour effectuer une avance ou un retour rapide.

[Q] : Recherche le fichier. (p.23)

[NORMAL]/[16:9]/[4:3] : Sélectionnez un mode d'écran.

■ Sélection d'une piste dans une liste (Recherche le fichier)

- 1 Touchez [Q].
- 2 Sélectionnez le mode de recherche par fichiers audio , fichiers vidéo .
- 3 Toucher [- 4 Touchez le dossier de votre choix.
Le contenu d'un dossier est affiché lorsque vous touchez celui-ci.
 - Toucher [
- 5 Touchez l'élément de votre choix dans la liste des contenus.
La lecture commence.

REMARQUE

- Touchez [

iPod/iPhone

Préparation

■ Connexion d'un iPod/iPhone

- Pour les modèles de paratonnerre : Utilisez le câble Audio USB pour iPod/iPhone—KS-U62 (accessoire optionnel).
- Pour en savoir plus sur la connexion iPod/iPhone, voir page 31.

1 Retirer le capuchon de la borne USB.

2 Branchez l'iPod/iPhone.

L'appareil lit le périphérique et la lecture commence.

■ Pour débrancher l'iPod/iPhone

1 Appuyez sur le bouton <🏠>.

2 Toucher une source autre que [iPod].

3 Débranchez l'iPod/l'iPhone.

■ iPod/iPhone connectables

Les modèles suivants peuvent être reliés à cet appareil.

Convient pour

- | | | |
|------------------------------|---------------------|------------------|
| • iPhone 12 Pro Max | • iPhone 11 Pro Max | • iPhone 8 Plus |
| • iPhone 12 Pro | • iPhone 11 Pro | • iPhone 8 |
| • iPhone 12 | • iPhone 11 | • iPhone 7 Plus |
| • iPhone 12 mini | • iPhone XS Max | • iPhone 7 |
| • iPhone SE (2nd generation) | • iPhone XS | • iPhone SE |
| | • iPhone XR | • iPhone 6s Plus |
| | • iPhone X | • iPhone 6s |
| | | • iPhone 6 Plus |

📎 REMARQUE

- Si vous démarrez la lecture après avoir connecté l'iPod, la musique qui a été lue par l'iPod est jouée en premier.
- Fermer le port USB quand il n'est pas utilisé.

Options de lecture

■ L'écran de commande de la source vous permet de gérer la musique que vous écoutez.



1 Illustration (Affiché si la piste contient un visuel)

2 Affiche les informations concernant le fichier en cours.

3 Temps de lecture/Numéro de fichier
Barre du temps de lecture : Pour confirmer la position actuelle de lecture.

4 [⏪] : Sélectionne le mode de lecture aléatoire.

[🔄] : Sélectionne le mode de lecture répétée.

[⏸], [⏹] : Lit ou marque une pause.

[⏮], [⏭] : Recherche le contenu précédent/suivant.

Touchez et maintenez enfoncé pour effectuer une avance ou un retour rapide.

[🔍] : Recherche le contenu. (p.24)

■ Sélectionner un contenu dans la liste

1 Touchez [🔍].

2 Touchez l'élément de votre choix.

Le contenu d'une catégorie est affiché lorsque vous touchez celle-ci.

3 Touchez l'élément de votre choix dans la liste des contenus.

La lecture commence.

- Toucher [↶] pour aller au niveau hiérarchique supérieur.

📎 REMARQUE

- Touchez [↶] pour faire apparaître l'écran de contrôle source en haut de page.

Composants Externes **Contrôle de l'audio**

Utilisant des lecteurs audio/vidéo externes

■ Démarrer la lecture

- 1 Connecter un composant externe à la borne d'entrée AV-IN. (p.30)
- 2 Appuyez sur le bouton <🏠>.
- 3 Toucher [AV-IN].
- 4 Allumer le composant connecté et commencer à lire la source.

■ Pour la lecture de vidéo

- 1 Lorsque les touches de fonctionnement ne sont pas affichées à l'écran, toucher l'écran.

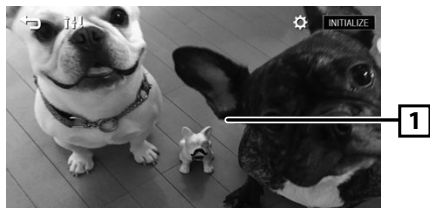

Caméra de recul

Pour utiliser la caméra de recul, le câble de connexion INVERSE est requis. Pour connecter une caméra de recul. (p.30)

■ Affiche l'image de la caméra de recul

L'écran de vue arrière est affiché lorsque vous changez de vitesse pour la position de marche arrière (R).



- Pour enlever le message de mise en garde, toucher l'écran.

Vous pouvez agir sur les différents paramètres, comme la balance audio ou le niveau du caisson de graves par exemple.

- 1 Appuyez sur le bouton <EQ>.
- 2 Veuillez consulter ce qui suit pour chaque méthode de fonctionnement.

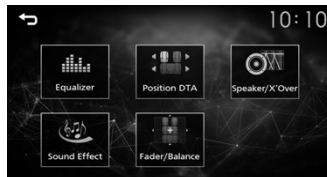

Contrôle de l'audio en général

- 1 Appuyez sur le bouton <EQ>.
- 2 Touchez [Fader / Balance].
- 3 Réglez chaque option comme suit.



[Fader Balance]

- | | |
|---------------------|--|
| Balance | Régler le volume de la balance à droite/ gauche. |
| [▶] [◀] | 15 (droite) à 15 (gauche) |
| Fader | Régler le volume de la balance avant/ arrière. |
| [▲] [▼] | 15 (avant) à 15 (arrière) |
| [INITIALIZE] | Pour effacer le réglage. |

Bluetooth

Enregistrer votre smartphone dans l'appareil

Vous pouvez utiliser votre smartphone Bluetooth lié à cet appareil.

- 1 Activer la fonction Bluetooth sur votre smartphone/téléphone portable.
- 2 Recherchez l'appareil (« KW-M27DBT ») à partir de votre smartphone/téléphone portable.

Si un code PIN est requis, entrez le code PIN (« 0000 »).

-  apparaît quand le Bluetooth du smartphone est connecté.

■ Déconnecter le périphérique

- Désactiver la fonction Bluetooth sur votre smartphone/téléphone portable.
- Mettre sur arrêt l'interrupteur d'allumage.

Recevoir un appel

- 1 Touchez [].

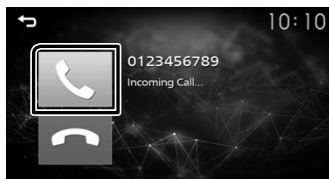

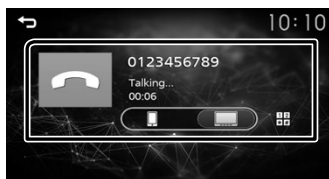

- [] : Rejeter un appel entrant.

■ Actions possibles pendant un appel



[] Raccrocher

[] Vous pouvez envoyer des tonalités en touchant les touches voulues à l'écran.
• Touchez [] pour fermer la fenêtre.

[] Bascule l'émission de la voix entre le smartphone/téléphone portable et le haut-parleur.

- Régler le volume de réception

Appuyez sur le bouton < + > ou < - >.

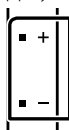



Passer un appel

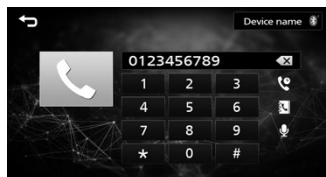



- 1 Appuyez sur le bouton <  >.
- 2 Appuyez sur [Phone].
- 3 Veuillez consulter le tableau ci-dessous pour chaque méthode de fonctionnement.





Appel par entrée d'un numéro de téléphone

- 1) Utilisez les touches numériques pour entrer un numéro de téléphone.
 - 2) Touchez [].
Effectuez un appel
- Touchez [] pour supprimer la dernière saisie.

Appel depuis l'historique des appels

- 1) Touchez [].
- 2) Touchez [] (appels entrants), [] (appels sortants), [] (appels manqués).
- 3) Sélectionnez dans la liste le numéro de téléphone.
Effectuez un appel

Appel depuis le répertoire téléphonique

- 1) Touchez [].
 - 2) Sélectionnez le nom dans la liste.
Effectuez un appel
- [] : Met à jour le répertoire téléphonique.
Touchez cette touche après avoir effectué une modification dans le répertoire de votre smartphone/téléphone portable.

Utilisation d'un appareil audio Bluetooth en lecture

1 Appuyez sur le bouton <🏠>.

2 Appuyez sur [BT Audio].

Écran de commande de source



1 Affiche les informations concernant le fichier en cours.

2 Temps de lecture/Numéro de fichier
Barre du temps de lecture : Pour confirmer la position actuelle de lecture.

- 3 [🔍] : Sélectionne le mode de lecture aléatoire.
[📄] : Sélectionne le mode de lecture répétée.
[▶], [⏸] : Lit ou marque une pause.
[◀], [▶] : Recherche le contenu précédent/suivant.
Touchez et maintenez enfoncé pour effectuer une avance ou un retour rapide.
[🔍] : Recherche le fichier. (p.27)

REMARQUE

- Certains indicateurs de fonctionnement et d'affichage peuvent différer en fonction de leur disponibilité sur l'appareil connecté.

Sélectionner un contenu dans la liste

1 Touchez [🔍].

2 Touchez l'élément de votre choix.

Le contenu d'une catégorie est affiché lorsque vous touchez celle-ci.

3 Touchez l'élément de votre choix dans la liste des contenus.

La lecture commence.

- Toucher [🏠] pour aller au niveau hiérarchique supérieur.

REMARQUE

- Touchez [🏠] pour faire apparaître l'écran de contrôle source en haut de page.

Avant l'installation

Avant d'installer cet appareil, veuillez prendre les mesures de précaution suivantes.

⚠️ AVERTISSEMENTS

- Si vous branchez le câble d'allumage (rouge) et le câble de la batterie (jaune) au châssis de la voiture (masse), il peut y avoir un court-circuit entraînant, à son tour, un incendie. Il faut toujours brancher ces câbles à la source d'alimentation fonctionnant via le boîtier de fusibles.
- Ne débranchez pas le fusible du câble d'allumage (rouge) ni du câble de la batterie (jaune). L'alimentation électrique doit être connectée aux câbles via le fusible.

⚠️ ATTENTION

- Installez cet appareil dans la console du véhicule. Ne touchez pas les éléments métalliques de cet appareil pendant et juste après l'utilisation de l'appareil. Les éléments métalliques tels que le dissipateur thermique et le coffret sont très chauds.

🔧 REMARQUE

- Le montage et le câblage de ce produit requièrent expérience et savoir-faire. Pour des questions de sécurité, les travaux de montage et de câblage doivent être effectués par des professionnels.
- Veillez à brancher l'appareil à une alimentation électrique négative de 12 Vcc avec mise à la terre.
- N'installez pas l'appareil dans un endroit directement exposé aux rayons du soleil, à une chaleur excessive ou à l'humidité. Évitez également les endroits trop poussiéreux ou susceptibles d'être éclaboussés par de l'eau.
- N'utilisez pas vos propres vis. N'utilisez que les vis fournies. L'utilisation de vis non appropriées risque d'endommager l'appareil.
- Si l'allumage de votre véhicule ne possède pas de position ACC, branchez les câbles d'allumage à une source d'alimentation que la clé de contact peut allumer ou éteindre. Si vous branchez le câble d'allumage à une source d'alimentation à tension constante comme les câbles de la batterie, il se peut que la batterie se décharge.
- Si la console est dotée d'un couvercle, veillez à installer l'appareil de sorte que la façade ne heurte pas le couvercle quand elle s'ouvre ou se ferme.
- Si le fusible saute, vérifiez d'abord que les câbles ne se touchent pas afin d'éviter tout court-circuit, puis remplacez l'ancien fusible par un nouveau fusible de même puissance.
- Isolez les câbles non connectés avec un ruban vinyl, ou tout autre matériau similaire. Pour éviter tout court-circuit, ne retirez pas les capuchons placés aux extrémités des câbles non connectés ou des bornes.

Installation

- Fixez les fils à l'aide de colliers et enroulez le ruban de vinyle autour des fils qui entre en contact avec les parties métalliques afin de protéger les fils et éviter tout court-circuit.
- Branchez correctement les câbles de l'enceinte aux bornes correspondantes. L'appareil peut subir des dommages et ne plus fonctionner si vous partagez les fils \ominus ou les mettez à la masse avec une partie métallique du véhicule.
- Si seulement deux enceintes sont branchées au système, branchez les connecteurs soit aux bornes de sortie avant soit aux bornes de sortie arrière (ne pas mélanger les bornes de sortie avant et arrière). Par exemple, si vous connectez le connecteur \oplus de l'enceinte gauche à une borne de sortie avant, ne connectez pas le connecteur \ominus à une borne de sortie arrière.
- Une fois l'appareil installé, vérifiez que les feux de freinage, les clignotants et les essuie-glace, etc. du véhicule fonctionnent correctement.
- L'angle de montage de l'appareil doit être inférieur ou égal à 30°.
- N'exercez pas de pression excessive sur la surface du panneau lors de l'installation de l'appareil dans le véhicule. Cela risque de rayer la surface, de l'endommager ou d'entraîner une défaillance.
- Il se peut que la réception soit mauvaise si des objets métalliques se trouvent à proximité de l'antenne Bluetooth.

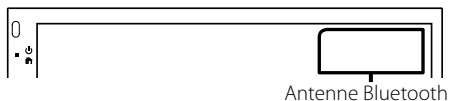

■ Accessoires fournis pour l'installation

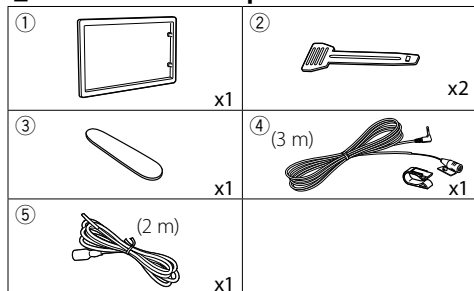

■ Procédure d'installation

- 1) Pour éviter les courts-circuits, retirez la clé de contact, puis débranchez la borne \ominus de la batterie.
- 2) Veillez à effectuer correctement les connexions des câbles d'entrée et de sortie pour chaque appareil.
- 3) Branchez le connecteur ISO sur l'appareil.
- 4) Installez l'appareil dans votre véhicule.
- 5) Reconnectez la borne \ominus de la batterie.
- 6) Appuyez sur le bouton réinitialiser.

Installation de l'appareil

■ Voitures non-japonaises

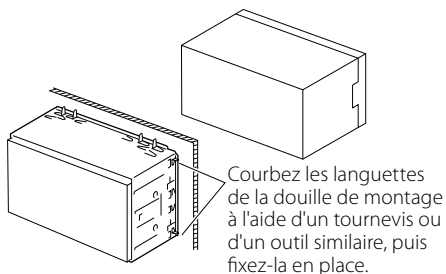

🔑 REMARQUE

- Vérifiez que l'appareil est correctement en place. Si l'appareil n'est pas stable, cela peut occasionner un dysfonctionnement (le son peut par exemple sauter).

■ Plaque de garniture

- 1) Fixez l'accessoire ① sur l'appareil.

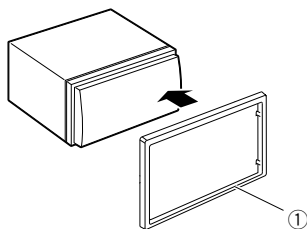

Installation

■ Microphone

- 1) Vérifiez la position d'installation du microphone (accessoire ④).
- 2) Nettoyez la surface d'installation.
- 3) Retirez le séparateur du microphone (accessoire ④) et collez le microphone à l'emplacement indiqué ci-dessous.
- 4) Branchez le câble du microphone sur l'appareil en le fixant à divers endroits à l'aide de ruban adhésif ou de toute autre méthode appropriée.
- 5) Réglez l'orientation du microphone (accessoire ④) en direction du conducteur.

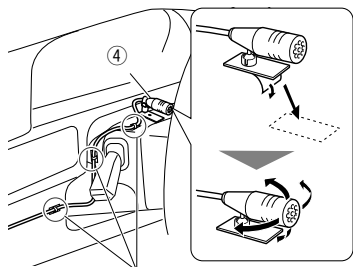

Fixez un câble avec du ruban spécialement prévu à cet effet.

✎ REMARQUE

- Échanger les attaches si nécessaire.

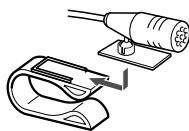

■ Retrait de la plaque de garniture

- 1) Utilisez la clé d'extraction (accessoire ③) pour sortir les quatre languettes (deux sur la partie gauche, deux sur la partie droite) en effectuant un mouvement de levier.

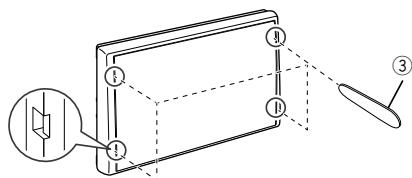

- 2) Tirer la plaque de garniture vers l'avant.

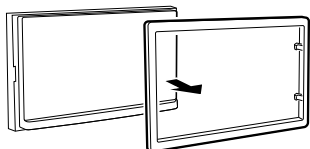

■ Retrait de l'appareil

- 1) Retirez la plaque de garniture en vous référant à l'étape 1 dans « Retrait de la plaque de garniture ».
- 2) Insérez la clé d'extraction (accessoire ②) profondément dans l'emplacement, comme illustré. (La saillie à la pointe de la clé d'extraction doit faire face à l'appareil.)

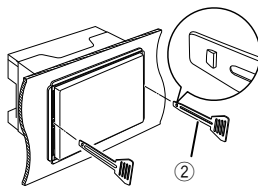

- 3) Une fois que vous avez correctement inséré la clé d'extraction, insérez l'autre clé d'extraction dans l'emplacement.

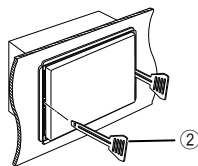

- 4) Extraire l'appareil à moitié.

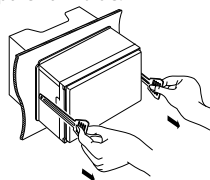

✎ REMARQUE

- Veillez à ne pas vous blesser avec les broches d'arrêt sur la clé d'extraction.
- 5) Tenez l'appareil des deux mains et faites-le sortir complètement en veillant à ne pas le laisser tomber.

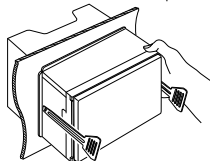

Installation

Connexion des câbles sur les contacts électriques

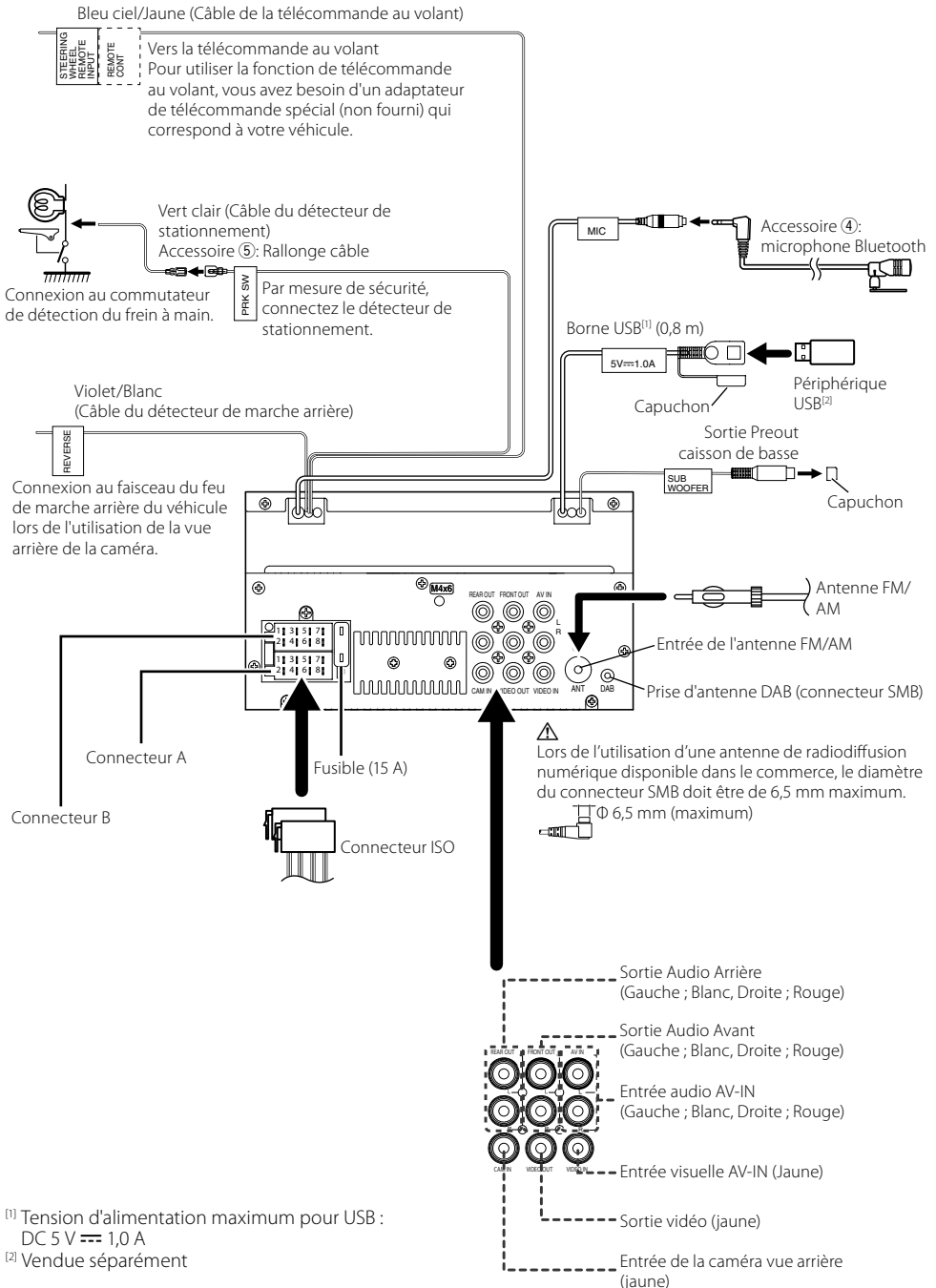

^[1] Tension d'alimentation maximum pour USB : DC 5 V = 1,0 A

^[2] Vendue séparément

Installation

■ Guide de fonctionnement des connecteurs du faisceau de câbles

Broche	Couleur et fonction	
A-4	Jaune	Batterie
A-5	Bleu/Blanc ^[1]	Réglage de puissance
A-7	Rouge	Allumage (ACC)
A-8	Noir	Branchement à la terre (masse)
B-1/B-2	Violet (+)/Violet/Noir (-)	Arrière droit
B-3/B-4	Gris (+)/Gris/Noir (-)	Avant droit
B-5/B-6	Blanc (+)/Blanc/Noir (-)	Avant gauche
B-7/B-8	Vert (+) / Vert/Noir (-)	Arrière gauche

^[1] Max. 150 mA, 12 V

- Impédance d'enceinte : 4-8 Ω

⚠ ATTENTION

Avant de connecter les connecteurs ISO (disponibles dans le commerce) à l'unité, vérifier les conditions suivantes :

- Veiller à ce que l'affectation des broches du connecteur corresponde à l'unité JVC.
- Prendre un avis supplémentaire pour le câble d'alimentation.
- Si les câbles d'alimentation et de contact ne correspondent pas, les changer en conséquence.
- Si le véhicule ne dispose pas d'un câble de démarrage, utiliser une interface disponible dans le commerce.

■ Branchement d'un iPod/iPhone/Android

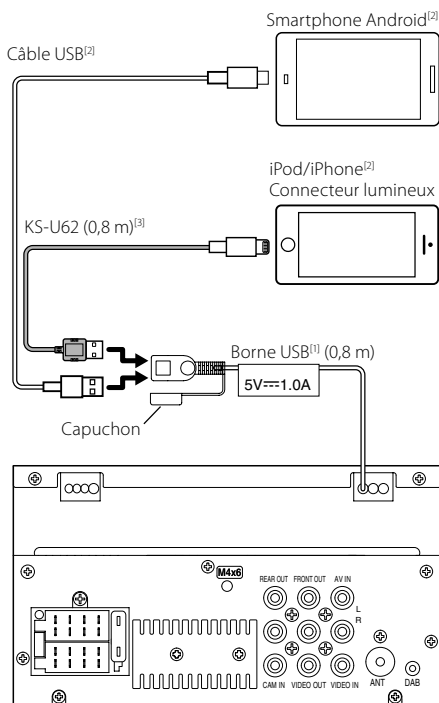

^[1] Tension d'alimentation maximum pour USB :
DC 5 V --- 1,0 A

^[2] Vendue séparément

^[3] Accessoire proposé en option

À propos de cet appareil

Plus d'informations

■ Périphérique USB utilisable

Cet appareil peut lire les fichiers MPEG1/ MPEG2/ MPEG4/ H.264/ MKV/ MP3/WMA/ AAC/ WAV/ FLAC/ OGG stockés dans un périphérique de stockage de masse USB.

- Système de fichier : FAT16/ FAT32

✎ REMARQUE

- Quand la périphérique USB est connectée à cet appareil, elle peut être chargée avec le câble USB.
- Installer la périphérique USB de façon à ce que cela ne vous empêche pas de conduire prudemment.
- Vous ne pouvez pas connecter de périphérique USB au moyen d'un hub USB et d'un lecteur multi-cartes.
- Faites des sauvegardes des fichiers audio utilisés avec cet appareil. Les fichiers peuvent être effacés en fonction des conditions de fonctionnement du périphérique USB.
Nous ne proposons pas d'indemnités pour les pertes dues à l'effacement de données.
- Aucun périphérique USB n'est fourni avec cet appareil. Vous devez acheter un périphérique USB disponible dans le commerce.
- Fermer le port USB quand il n'est pas utilisé.

■ Fichiers audio lisibles

Format audio	Extension
MP3	.mp3
WMA	.wma
AAC-LC	.m4a, .aac
PCM linéaire (WAVE)	.wav
FLAC	.flac
Vorbis	.ogg

- Cette unité peut montrer ID3 Tag Version 1.0/1.1/2.2/2.3/2.4 (pour MP3).

✎ REMARQUE

- Les formats WMA et AAC protégés par GDN ne peuvent pas être lus.
- Bien que les fichiers audio soient conformes aux normes susmentionnées, la lecture peut se révéler impossible en fonction des lectures et conditions du support ou du périphérique.

■ Fichiers vidéo acceptés

Format vidéo	Extension
MPEG-1	.mpg, .mpeg
MPEG-2	.mpg, .mpeg
MPEG-4	.mp4, .avi
H.264/MPEG-4 AVC	.mp4, .mkv, .avi, .flv, .f4v, .ts
MKV	.mkv

Remarques concernant les spécifications

■ Section Bluetooth

Fréquence

: 2,402 – 2,480 GHz

Puissance de sortie

: +8 dBm (AVE), classe de puissance 1

■ Général

Impédance d'enceinte

: 4 – 8 Ω

Tension de fonctionnement

: batterie de voiture 12 V CC

Copyrights

- La marque du mot et les logos Bluetooth® sont des marques déposées de Bluetooth SIG, Inc. et toute utilisation de ces marques par JVC/KENWOOD est faite sous licence. Les autres marques déposées et appellations commerciales appartiennent à leurs propriétaires respectifs.
- Use of the Made for Apple badge means that an accessory has been designed to connect specifically to the Apple product(s) identified in the badge and has been certified by the developer to meet Apple performance standards. Apple is not responsible for the operation of this device or its compliance with safety and regulatory standards. Please note that the use of this accessory with an Apple product may affect wireless performance.
- Apple, iPhone, iPod, iPod touch, and Lightning are trademarks of Apple Inc., registered in the U.S. and other countries.
- Microsoft and Windows Media are either registered trademarks or trademarks of Microsoft Corporation in the United States and/or other countries.
- THIS PRODUCT IS LICENSED UNDER THE MPEG-4 VISUAL PATENT PORTFOLIO LICENSE FOR THE PERSONAL AND NON-COMMERCIAL USE OF A CONSUMER FOR (i) ENCODING VIDEO IN COMPLIANCE WITH THE MPEG-4 VISUAL STANDARD ("MPEG-4 VIDEO") AND/OR (ii) DECODING MPEG-4 VIDEO THAT WAS ENCODED BY A CONSUMER ENGAGED IN A PERSONAL AND NON-COMMERCIAL ACTIVITY AND/OR WAS OBTAINED FROM A VIDEO PROVIDER LICENSED BY MPEG LA TO PROVIDE MPEG-4 VIDEO. NO LICENSE IS GRANTED OR SHALL BE IMPLIED FOR ANY OTHER USE. ADDITIONAL INFORMATION INCLUDING THAT RELATING TO PROMOTIONAL, INTERNAL AND COMMERCIAL USES AND LICENSING MAY BE OBTAINED FROM MPEG LA, LLC. SEE [HTTP://WWW.MPEGLA.COM](http://www.mpegla.com).

À propos de cet appareil

- THIS PRODUCT IS LICENSED UNDER THE AVC PATENT PORTFOLIO LICENSE FOR THE PERSONAL USE OF A CONSUMER OR OTHER USES IN WHICH IT DOES NOT RECEIVE REMUNERATION TO (j)ENCODE VIDEO IN COMPLIANCE WITH THE AVC STANDARD ("AVC VIDEO") AND/OR (jj)DECODE AVC VIDEO THAT WAS ENCODED BY A CONSUMER ENGAGED IN A PERSONAL ACTIVITY AND/OR WAS OBTAINED FROM A VIDEO PROVIDER LICENSED TO PROVIDE AVC VIDEO. NO LICENSE IS GRANTED OR SHALL BE IMPLIED FOR ANY OTHER USE. ADDITIONAL INFORMATION MAY BE OBTAINED FROM MPEG LA, L.L.C. SEE [HTTP://WWW.MPEGLA.COM](http://www.mpegla.com)

• libFLAC

Copyright (C) 2000-2009 Josh Coalson

Copyright (C) 2011-2013 Xiph.Org Foundation

– Redistribution and use in source and binary forms, with or without modification, are permitted provided that the following conditions are met:

– Redistributions of source code must retain the above copyright notice, this list of conditions and the following disclaimer.

– Redistributions in binary form must reproduce the above copyright notice, this list of conditions and the following disclaimer in the documentation and/or other materials provided with the distribution.

Neither the name of the Xiph.org Foundation nor the names of its contributors may be used to endorse or promote products derived from this software without specific prior written permission.

THIS SOFTWARE IS PROVIDED BY THE COPYRIGHT HOLDERS AND CONTRIBUTORS "AS IS" AND ANY EXPRESS OR IMPLIED WARRANTIES, INCLUDING, BUT NOT LIMITED TO, THE IMPLIED WARRANTIES OF MERCHANTABILITY AND FITNESS FOR A PARTICULAR PURPOSE ARE DISCLAIMED. IN NO EVENT SHALL THE FOUNDATION OR CONTRIBUTORS BE LIABLE FOR ANY DIRECT, INDIRECT, INCIDENTAL, SPECIAL, EXEMPLARY, OR CONSEQUENTIAL DAMAGES (INCLUDING, BUT NOT LIMITED TO, PROCUREMENT OF SUBSTITUTE GOODS OR SERVICES; LOSS OF USE, DATA, OR PROFITS; OR BUSINESS INTERRUPTION) HOWEVER CAUSED AND ON ANY THEORY OF LIABILITY, WHETHER IN CONTRACT, STRICT LIABILITY, OR TORT (INCLUDING NEGLIGENCE OR OTHERWISE) ARISING IN ANY WAY OUT OF THE USE OF THIS SOFTWARE, EVEN IF ADVISED OF THE POSSIBILITY OF SUCH DAMAGE.

• libogg

Copyright (c) 2002, Xiph.org Foundation Redistribution and use in source and binary forms, with or without modification, are permitted provided that the following conditions are met:

– Redistributions of source code must retain the above copyright notice, this list of conditions and the following disclaimer.

– Redistributions in binary form must reproduce the above copyright notice, this list of conditions and the following disclaimer in the documentation and/or other materials provided with the distribution.

– Neither the name of the Xiph.org Foundation nor the names of its contributors may be used to endorse or promote products derived from this software without specific prior written permission.

THIS SOFTWARE IS PROVIDED BY THE COPYRIGHT HOLDERS AND CONTRIBUTORS "AS IS" AND ANY EXPRESS OR IMPLIED WARRANTIES, INCLUDING, BUT NOT LIMITED TO, THE IMPLIED WARRANTIES OF MERCHANTABILITY AND FITNESS FOR A PARTICULAR PURPOSE ARE DISCLAIMED. IN NO EVENT SHALL THE FOUNDATION OR CONTRIBUTORS BE LIABLE FOR ANY DIRECT, INDIRECT, INCIDENTAL, SPECIAL, EXEMPLARY, OR CONSEQUENTIAL DAMAGES (INCLUDING, BUT NOT LIMITED TO, PROCUREMENT OF SUBSTITUTE GOODS OR SERVICES; LOSS OF USE, DATA, OR PROFITS; OR BUSINESS INTERRUPTION) HOWEVER CAUSED AND ON ANY THEORY OF LIABILITY, WHETHER IN CONTRACT, STRICT LIABILITY, OR TORT (INCLUDING NEGLIGENCE OR OTHERWISE) ARISING IN ANY WAY OUT OF THE USE OF THIS SOFTWARE, EVEN IF ADVISED OF THE POSSIBILITY OF SUCH DAMAGE.

■ Information sur l'élimination des anciens équipements électriques et électroniques et piles électriques (applicable dans les pays de l'Union Européenne qui ont adopté des systèmes de collecte sélective)

Les produits et les batteries comprenant le symbole (poubelle barrée) ne peuvent pas être jetés parmi les déchets ménagers.

Les anciens équipements électriques et électroniques et les piles électriques doivent être recyclés sur des sites capables de traiter ces produits et leurs sous-produits déchets.

Contactez vos autorités locales pour connaître le site de recyclage le plus proche.

Recycler de manière adaptée et jeter ses déchets au bon endroit aide à préserver les ressources tout en évitant les effets néfastes sur notre santé et l'environnement.



Inhalt

Vor Verwendung	34
Hinweise zu diesem Handbuch	34
Vorsichtsmaßnahmen.....	34
Erste Schritte.....	35
Uhreinstellungen.....	35
Grundlagen.....	36
Tastenfunktionen auf dem Frontpanel.....	36
Allgemeine Funktionen.....	36
HOME-Bildschirm.....	36
Quellensteuerungsbildschirm	36
Digitalradio	37
Grundfunktionen des Digitalradios.....	37
Digitalradio-Einrichtung	37
TUNER.....	38
Tuner-Grundfunktionen.....	38
Radiosetup	38
USB	39
Vorbereitung.....	39
Wiedergabefunktionen.....	39
iPod/iPhone	40
Vorbereitung.....	40
Wiedergabefunktionen.....	40
Externe Komponenten	41
Nutzung von externen Audio-/Videoplayern	41
Rückfahrkamera	41
Audio-Steuerung	41
Allgemeine Audio-Steuerung	41
Bluetooth	42
Smartphone am Gerät anmelden.....	42
Telefonanrufe annehmen.....	42
Telefonanrufe tätigen.....	42
Wiedergabe mit einem Bluetooth-Audiogerät.....	43
Installation.....	43
Vor der Installation	43
Installation des Geräts	44
Wissenswertes über dieses Gerät.....	48
Weitere Informationen	48
Hinweis zu den Spezifikationen	48
Urheberrechte.....	48

- Detaillierte Anweisungen und Informationen finden Sie in der **BEDIENUNGSANLEITUNG** auf der folgenden Website:

<<https://www.jvc.net/cs/car/>>



Hinweise zu diesem Handbuch

- Die in dieser Anleitung gezeigten Bedienelemente sind Beispiele, die zur Verdeutlichung der Funktionen dienen sollen. Aus diesem Grund kann es zu Abweichungen vom vorliegenden Panel kommen.
- Bei der Beschreibung von Bedienvorgängen verweisen eckige Klammern auf Touchkeys bzw. Tasten, die Sie bedienen sollen.
< >: Bezeichnung der Tasten auf dem Panel.
[]: Bezeichnung der Touchkeys.

Vor Verwendung

Vorsichtsmaßnahmen

▲ WARNUNG

■ Folgende Vorsichtsmaßnahmen beachten, um Brand oder Verletzungen zu vermeiden:

- Kurzschlüsse verhindern. Niemals Metallgegenstände (z. B. Münzen oder Werkzeug) ins Gerät stecken oder darin belassen.
- Verfolgen Sie die Anzeige des Geräts während der Fahrt nicht für längere Zeit.
- Falls bei der Installation Probleme auftreten, nehmen Sie Kontakt mit Ihrem JVC-Händler auf.

■ Vorsichtsmaßnahmen bei der Verwendung dieses Gerätes

- Falls Sie optionale Zusatzgeräte kaufen, wenden Sie sich an Ihren JVC-Händler, um sicherzustellen, dass sie mit Ihrem Modell kompatibel sind und in Ihrer Region verwendet werden können.
- Das Radio Data System bzw. Radio Broadcast Data System funktioniert nur in Regionen mit Sendern, die diese Dienste unterstützen.

■ Schutz des Monitors

- Um den Monitor vor Beschädigungen zu schützen, sollten Sie ihn nicht mit einem Kugelschreiber oder einem ähnlichen spitzen Gegenstand bedienen.

■ Gerät reinigen

Ist das Frontpanel des Geräts verschmutzt, reinigen Sie es mit einem weichen, trockenen Tuch, z. B. mit einem Silikon Tuch. Ist das Frontpanel stark verschmutzt, entfernen Sie den Schmutz mit einem angefeuchteten Tuch (mit neutralem Reinigungsmittel) und wischen Sie es anschließend wieder mit einem weichen trockenen Tuch ab.

▲ ACHTUNG

- Kein Reinigungsmittel direkt auf das Gerät sprühen. Dies könnte die mechanischen Bauteile beschädigen. Das Frontpanel nicht mit einem harten Tuch oder Lösungsmitteln wie z. B. Verdünnern oder Alkohol reinigen. Dies könnte die Oberfläche zerkratzen oder Aufdrucke ablösen.

■ Gerät zurücksetzen

Falls das Gerät bzw. das angeschlossene Gerät nicht richtig funktioniert, Gerät zurücksetzen.

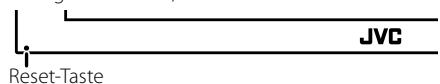

Dieses Symbol auf dem Produkt bedeutet, dass es in dieser Anleitung wichtige Betriebs- und Wartungsanweisungen gibt. Lesen Sie stets die Anweisungen in dieser Anleitung sorgfältig durch.

Erste Schritte

1 Stellen Sie den Zündschlüssel Ihres Autos auf "ACC".

Das Gerät ist eingeschaltet.

2 Drücken Sie die <🏠>-Taste.

3 Berühren Sie [⚙️].



4 Drücken Sie den entsprechenden Touchkey und stellen Sie den Wert ein.



[System]

[Beep Tone]

Aktiviert oder deaktiviert den Tastenberührungston.
„ON“ (EIN) (Werkseinstellung), „OFF“ (AUS)

[Language]

Wählen Sie die für den Steuerungsbildschirm und die Einstellungselemente zu verwendende Sprache. Die Werkseinstellung ist „English“ (Englisch).

[Time/Date]

Stellen Sie die Uhrzeit ein. (S.35)

[Clock Mode]

Wählen Sie das Anzeigeformat für die Uhrzeit aus. [12hr]/[24hr] (Werkseinstellung)

[Parking Guidelines]

Sie können den Parkassistent anzeigen, um das Einparken zu erleichtern, wenn Sie in den Rückwärtsgang (R) schalten. Werkseinstellung ist „ON“.

[Guidelines SETUP]

Sie können die Einpark-Hilfslinien anpassen, wenn Sie [ON] für [Parking Guidelines] ausgewählt haben.

[System Reset]

Berühren Sie [System Reset] und berühren Sie dann [YES], um alle Einstellungen auf die anfänglichen Standardeinstellungen zurückzusetzen.

[Bluetooth]

Zeigt den Bildschirm für die Bluetooth-Einstellungen an.

[Screen]

[Dimmer]

Wählen Sie den Helligkeitsmodus aus. „High“ (Werkseinstellung), „Mid“, „Low“

[Demo]

Wählen Sie den Demonstrationsmodus aus. Werkseinstellung ist „ON“.

[Information]

Zeigt die Software-Version dieses Geräts an.

5 Berühren Sie [↶].

Uhreinstellungen

☑ Synchronisiert die Uhrzeit mit FM RDS

Aktiviert [RDS Clock Sync] (RDS-Uhr synchron.).
Siehe **RadioSetup (S.38)**.

☑ Die Uhr manuell einstellen

📎 HINWEIS

- Deaktivieren Sie [RDS Clock Sync], bevor Sie die Uhrzeit einstellen.

1 Drücken Sie die <🏠>-Taste.

2 Berühren Sie [⚙️].

3 Berühren Sie [System].

4 Berühren Sie [Time/Date].

Der Uhrbildschirm erscheint.

5 Berühren Sie [▲] oder [▼], um die Uhrzeit einzustellen.



6 Berühren Sie [↶].

Grundlagen

Tastenfunktionen auf dem Frontpanel



- 1 Fernbedienung**
 - Empfängt das Fernbedienungssignal.
- 2 (HOME)**
 - Zeigt den HOME-Bildschirm an. **(S.36)**
 - Drücken Sie die Taste länger als 1 Sekunde, um die Stromversorgung auszuschalten.
 - Ist die Stromversorgung ausgeschaltet, wird sie hierdurch eingeschaltet.
- 3 EQ**
 - Zeigt den Audio-Bildschirm an.* **(S.41)**
 - * Der Audiobildschirm wird nicht angezeigt, wenn der EINRICHTUNGS-Bildschirm angezeigt wird, oder auf dem Listenbildschirm usw.
- 4 +, - (Lautstärke)**
 - Lautstärkeregelung. Die Lautstärke wird bis 20 erhöht, wenn Sie [+] weiter drücken.
- 5 (MUTE, Anzeige aus)**
 - Schaltet den Ton stumm/stellt ihn wieder her.
 - Drücken Sie die Taste länger als 1 Sekunde, um den Bildschirm auszuschalten.
 - Wenn der Bildschirm ausgeschaltet ist, berühren Sie die Anzeige, um den Bildschirm einzuschalten.
- 6 Zurücksetzen**
 - Wenn das Gerät oder das angeschlossene Gerät nicht richtig funktioniert, wird das Gerät auf die Werkseinstellungen zurückgesetzt, sobald diese Taste gedrückt wird.

Allgemeine Funktionen

Das Gerät einschalten

1 Drücken Sie die -Taste.



Das Gerät ausschalten

1 Halten Sie die Taste gedrückt.

HOME-Bildschirm

1 Drücken Sie die -Taste.

Der HOME-Bildschirm erscheint.



- Uhranzeige
- Schaltet auf Radio um. **(S.38)**
- [USB]**
 - Gibt die Dateien auf einem USB-Gerät wieder. **(S.39)**
 - [iPod]**
 - Spielt einen iPod/ein iPhone ab. **(S.40)**
 - Wenn ein iPod/iPhone angeschlossen ist.
 - [Mirroring]**
 - Zeigt den Spiegelungsbildschirm an.
 - Wenn ein Android-Gerät mit der installierten Anwendung „Mirroring OB for JVC“ verbunden ist.
- Wechselt zu einer externen Komponente, die an den AV-IN-Eingangsanschluss angeschlossen ist. **(S.41)**
- Zeigt den Freisprechbildschirm an. **(S.42)**
- Spielt einen Bluetooth-Audioplayer ab. **(S.43)**
- Schaltet auf DAB-Radio um. **(S.37)**
- Zeigt den SETUP-Bildschirm an. **(S.35)**

Quellensteuerungsbildschirm



- []**: Kehrt zum vorherigen Bildschirm zurück.
- []**: Zeigt den Audio-Bildschirm an. **(S.41)**

Digitalradio

Grundfunktionen des Digitalradios

- 1 Drücken Sie die <🏠>-Taste.
- 2 Berühren Sie [Digital Radio].

■ Quellensteuerungsbildschirm

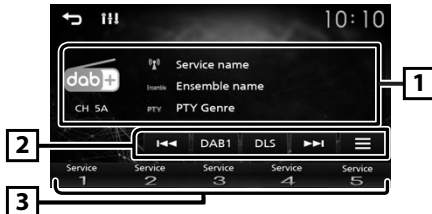

1 Zeigt die Informationen zum aktuellen Service an: Servicename, Ensemblename, PTY-Genre, Kanal

2 **[DAB]**: Schaltet das voreingestellte DAB-Band um.

„DAB1“, „DAB2“, „DAB3“

[DLS]: Zeigt den Bildschirm für die Textinformationen an.

[◀▶]: Wählen Sie ein Ensemble, einen Service und eine Komponente aus.

[☰]: Zeigt den Digitalradio-Einrichtungsbildschirm an. **(S.37)**

3 Ruft die gespeicherten Services auf.
Wenn Sie die Taste 2 Sekunden lang gedrückt halten, wird der gerade empfangene Service gespeichert.

■ Speichern eines Service

Sie können den aktuell empfangenen Service speichern.

- 1 Wählen Sie einen Service aus, den Sie voreinstellen möchten.
- 2 Berühren und halten Sie [#] fest (#:1-5), wo Sie den Service speichern möchten.

■ Auswahl eines gespeicherten Service

- 1 Berühren Sie [#] (#: 1-5).

Digitalradio-Einrichtung

- 1 Berühren Sie [☰].
- 2 Jedes Element wie folgt einstellen.



[Service List]

Zeigt den Servicelisten-Bildschirm an.

- **[☰]**: Berühren und dann [Yes] berühren, um die aktuellste Serviceliste zu finden.

[TI]

Wechselt automatisch zu den Verkehrsnachrichten, sobald die Verkehrsmeldung startet.

„ON“ (EIN), „OFF“ (AUS) (Werkseinstellung)

[PTY]

Sucht nach einem Programm nach der Programmsparte.

[Priority]

Falls der gleiche Dienst auch über das Radiodaten-system angeboten wird, wenn der Empfang eines über Digital-Radio angebotenen Dienstes schlecht geworden ist, wird automatisch auf das Radiodaten-system umgeschaltet.

„ON“ (EIN), „OFF“ (AUS) (Werkseinstellung)

[Announcement Select]

Schaltet auf den eingestellten Ansagedienst um.

[Related Service]

Wenn Sie „ON“ auswählen, schaltet das Gerät zu einem verwandten Service (wenn vorhanden), wenn kein DAB-Servicenetzwerk vorhanden ist. Werkseinstellung ist „OFF“.

[Antenna Power]

Schaltet die Stromversorgung für die Digital-Radio-Antenne ein. Auf „ON“ einstellen, wenn die verwendete Digital-Radio-Antenne mit einem Antennenverstärker ausgestattet ist. Werkseinstellung ist „ON“.

- 3 Berühren Sie [↩].

TUNER

Tuner-Grundfunktionen

- 1 Drücken Sie die <🏠>-Taste.
- 2 Berühren Sie [Tuner].

Quellensteuerungsbildschirm

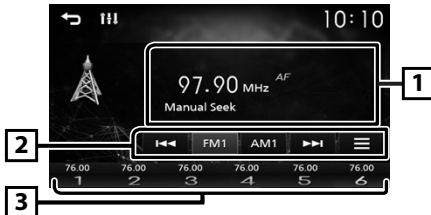

- 1 Zeigt die Information zum aktuellen Sender an: PS-Name, Frequenz, PTY-Genre, Anzeigeelemente
- 2 **[FM]**: Schaltet das UKW-Frequenzband um. „FM1“, „FM2“, „FM3“
[AM]: Schaltet das MW-Frequenzband um. „AM1“, „AM2“
[◀▶]: Stellt automatisch einen Sender mit gutem Empfang ein.
[☰]: Zeigt den Tuner-SETUP-Bildschirm an. (S.38)
- 3 Ruft den gespeicherten Sender auf. Wenn Sie die Taste 2 Sekunden lang gedrückt halten, wird der gerade empfangene Sender gespeichert.

Automatische Programmspeicherung

Sie können für das aktuelle Band (UKW1/UKW2/UKW3/MW1/MW2) 6 Sender voreinstellen.

- 1 Berühren Sie **[FM]** oder **[AM]**, um das Frequenzband auszuwählen.
- 2 Berühren Sie **[☰]**.
- 3 Berühren Sie **[Auto Store]**.
Die örtlichen Sender mit den stärksten Signalen werden gesucht und automatisch gespeichert.

Manuelle Speicherung

Sie können den aktuell empfangenen Sender im Senderspeicher speichern.

- 1 Wählen Sie einen Sender, den Sie voreinstellen möchten.
- 2 Berühren und halten Sie **[#]** fest (#:1-6), wo Sie den Sender speichern möchten.

Abrufen des gespeicherten Senders.

- 1 Berühren Sie **[#]** (#:1-6).

Radiosetup

- 1 Berühren Sie **[☰]**.
- 2 Jedes Element wie folgt einstellen.



[Auto Store]

Sucht und speichert die 6 Sender mit den stärksten Signalen automatisch für das ausgewählte Band. „Auto Store“ erscheint.

[Local Seek]

Stellt nur Sender mit ausreichender Signalstärke ein. (**LOC**-Anzeige leuchtet auf.) „ON“ (EIN), „OFF“ (AUS) (Werkseinstellung)

[RDS] *1

Zeigt den RDS-Einstellungsbildschirm an.

[AF]

Bei schlechtem Empfang eines bestimmten Radiosenders wird automatisch zu einem Sender umgeschaltet, der dasselbe Programm über dasselbe Radio-Data-System-Netzwerk sendet. „ON“ (EIN) (Werkseinstellung), „OFF“ (AUS)

[TA]

Wechselt automatisch zu den Verkehrsnachrichten, sobald die Verkehrsmeldung startet. (Die **TI**-Anzeige leuchtet auf.) „ON“ (EIN), „OFF“ (AUS) (Werkseinstellung)

[RDS Clock Sync]

Synchronisiert die Radiodatensystem-Sender-Zeitdaten und diese Geräteuhr. „ON“ (EIN) (Werkseinstellung), „OFF“ (AUS)

[PTY]

Wählen Sie eine Programmparte aus.

[PTY Seek]

Sucht nach einem Programm nach der Programmparte.

*1 nur UKW

- 3 Berühren Sie **[↩]**.

USB

Vorbereitung

■ Anschluss eines USB-Geräts

- 1 Nehmen Sie den Deckel des USB-Anschlusses ab.
- 2 USB-Gerät und USB-Kabel verbinden.

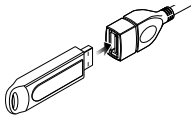

Das Gerät liest das Gerät und die Wiedergabe wird gestartet.

■ Zum Trennen der USB-Geräteverbindung:

- 1 Drücken Sie die <⏮>-Taste.
- 2 Berühren Sie eine andere Quelle als [USB].
- 3 Trennen Sie das USB-Gerät ab.

■ Verwendbare USB-Geräte

Dieses Gerät kann MPEG1/MPEG2/MPEG4/H.264/MKV/MP3/WMA/AAC/WAV/FLAC/OGG-Dateien wiedergeben, die auf einem USB-Massenspeicher gespeichert sind.

Wiedergabefunktionen

■ Steuern Sie die Wiedergabe der Musik am Quellensteuerungsbildschirm.

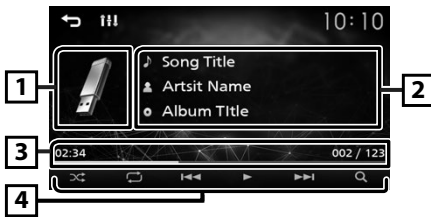

- 1 Die Hülle der aktuell abgespielten Datei wird angezeigt.
- 2 Zeigt die Information zur aktuellen Datei an.
- 3 Wiedergabezeit/Dateinummer
Wiedergabezeitleiste: Zur Bestätigung der aktuellen Wiedergabeposition
- 4 [⏮]: Wählt den Zufallswiedergabemodus aus.
[⏪]: Wählt den Wiederholungswiedergabemodus aus.
[▶], [⏸]: Wiedergabe oder Pause.

- [⏮], [⏪]: Sucht den vorigen/nächsten Inhalt. Für schnellen Vorlauf oder schnellen Rücklauf anhaltend drücken.
[Q]: Sucht die Datei. (S.39)

■ Für die Videowiedergabe

- 1 Wenn die Bedientasten nicht auf dem Bildschirm angezeigt werden, berühren Sie das Display.

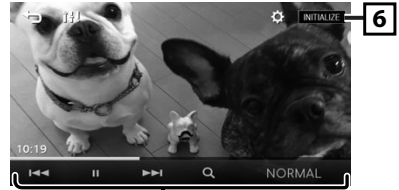

- 6 [⚙️]: Sie können die Bildqualität auf dem Videobildschirm anpassen.
[INITIALIZE]: Um die Anpassung zu löschen.
- 7 [▶], [⏸]: Wiedergabe oder Pause.
[⏮], [⏪]: Sucht den vorigen/nächsten Inhalt. Für schnellen Vorlauf oder schnellen Rücklauf anhaltend drücken.
[Q]: Sucht die Datei. (S.39)
[NORMAL]/[16:9]/[4:3]: Wählen Sie einen Bildschirmmodus aus.

■ Auswählen eines Titels in einer Liste (nach Datei suchen)

- 1 Berühren Sie [Q].
- 2 Wählen Sie aus, ob Sie nach Audiodateien [🎵] oder Videodateien [📺] suchen möchten.
- 3 Berühren Sie [⏮], um in die obere Hierarchie zu gelangen.
- 4 Drücken Sie auf den gewünschten Ordner. Berühren Sie einen Ordner, um den Ordnerinhalt anzuzeigen.
 - Berühren Sie [↵], um in die obere Hierarchie zu gelangen.
- 5 Gewünschtes Element der Liste drücken. Startet Wiedergabe.

📌 HINWEIS

- Wenn Sie [↵] in der obersten Hierarchie berühren, erscheint der Quellensteuerungsbildschirm.

Vorbereitung

■ Anschluss des iPods/iPhones

- Für Modelle mit Lightning-Anschluss: Nutzen Sie das USB-Audiokabel für iPod/iPhone—KS-U62 (optionales Zubehör).
- Für Details zum Anschluss eines iPods/iPhones siehe Seite 47.

1 Nehmen Sie den Deckel des USB-Anschlusses ab.

2 Schließen Sie das iPod/iPhone an.

Das Gerät liest das Gerät und die Wiedergabe wird gestartet.

■ Zum Trennen des iPods/iPhones

1 Drücken Sie die <⏪>-Taste.

2 Berühren Sie eine andere Quelle als [iPod].

3 Trennen Sie den iPod/das iPhone ab.

■ Anschließbare iPods/iPhones

Die nachfolgend aufgeführten Modelle können an dieses Gerät angeschlossen werden.

Konzipiert für

- | | | |
|------------------------------|---------------------|------------------|
| • iPhone 12 Pro Max | • iPhone 11 Pro Max | • iPhone 8 Plus |
| • iPhone 12 Pro | • iPhone 11 Pro | • iPhone 8 |
| • iPhone 12 | • iPhone 11 | • iPhone 7 Plus |
| • iPhone 12 mini | • iPhone XS Max | • iPhone 7 |
| • iPhone SE (2nd generation) | • iPhone XS | • iPhone SE |
| | • iPhone XR | • iPhone 6s Plus |
| | • iPhone X | • iPhone 6 Plus |

📎 HINWEIS

- Starten Sie die Wiedergabe nach Anschluss des iPods, wird zuerst die Musik wiedergegeben, die vom iPod abgespielt wurde.
- Setzen Sie den Deckel auf den USB-Anschluss auf, wenn er nicht verwendet wird.

Wiedergabefunktionen

■ Steuern Sie die Wiedergabe der Musik am Quellensteuerungsbildschirm.



- 1 Illustration (wird angezeigt, wenn der Titel eine Illustration enthält)
- 2 Zeigt die Information zur aktuellen Datei an.
- 3 Wiedergabezeit/Dateinummer
Wiedergabezeitleiste: Zur Bestätigung der aktuellen Wiedergabeposition
- 4 [⏪]: Wählt den Zufallswiedergabemodus aus.
[⏩]: Wählt den Wiederholungswiedergabemodus aus.
[▶], [⏸]: Wiedergabe oder Pause.
[⏮], [⏭]: Sucht den vorigen/nächsten Inhalt. Für schnellen Vorlauf oder schnellen Rücklauf anhaltend drücken.
[🔍]: Sucht den Inhalt. **(S.40)**

■ Einen Inhalt in einer Liste auswählen

1 Berühren Sie [📁].

2 Drücken Sie auf die gewünschte Option.

Wenn Sie eine Kategorie berühren, werden ihre Inhalte angezeigt.

3 Gewünschtes Element der Liste drücken.

Startet Wiedergabe.

- Berühren Sie [📁], um in die obere Hierarchie zu gelangen.

📎 HINWEIS

- Wenn Sie [📁] in der obersten Hierarchie berühren, erscheint der Quellensteuerungsbildschirm.

Externe Komponenten

Nutzung von externen Audio-/ Videoplayern

Wiedergabe starten

- 1 Schließen Sie eine externe Komponente an den AV-IN-Eingangsanschluss an. (S.46)
- 2 Drücken Sie die <Home>-Taste.
- 3 Berühren Sie [AV-IN].
- 4 Schalten Sie die angeschlossene Komponente ein und beginnen Sie damit, die Quelle wiederzugeben.

Für die Videowiedergabe

- 1 Wenn die Bedientasten nicht auf dem Bildschirm angezeigt werden, berühren Sie das Display.

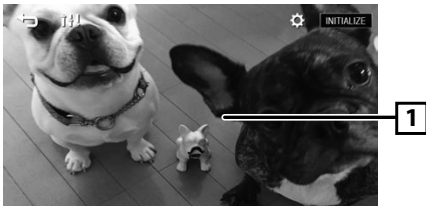

Rückfahrkamera

Um eine Rückfahrkamera nutzen zu können, ist die RÜCKWÄRTS-Kabelverbindung erforderlich. Zum Anschluss einer Rückfahrkamera. (S.46)

Anzeige des Bildes von der Rückfahrkamera

Der Rückansichtsbildschirm wird angezeigt, wenn Sie in den Rückwärtsgang (R) schalten.



- Berühren Sie den Bildschirm, um die Warnmeldung zu löschen.

Audio-Steuerung

Sie können unterschiedliche Einstellungen wie die Audiobalance oder den Subwooferpegel einstellen.

- 1 Drücken Sie die <EQ>-Taste.
- 2 Nachfolgend finden Sie die jeweilige Betriebsmethode.



Allgemeine Audio-Steuerung

- 1 Drücken Sie die <EQ>-Taste.
- 2 Berühren Sie [Fader / Balance].
- 3 Jedes Element wie folgt einstellen.

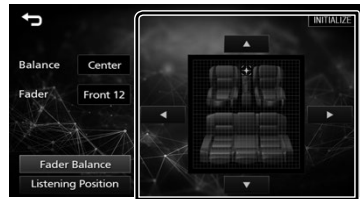

[Fader Balance]

Balance Stellen Sie die linke und rechte Lautstärke-Balance ein.
 [▶] [◀]
 15 (rechts) bis 15 (links)

Fader Stellt die vordere und hintere Lautstärke-Balance ein.
 [▲] [▼]
 15 (vorn) bis 15 (hinten)

[INITIALIZE] Um die Anpassung zu löschen.

Bluetooth

Smartphone am Gerät anmelden

Sie können Ihr Bluetooth-Smartphone verwenden, wenn es mit diesem Gerät verbunden ist.

- 1 Schalten Sie die Bluetooth-Funktion an Ihrem Smartphone/Mobiltelefon ein.
- 2 Suchen Sie das Gerät („KW-M27DBT“) auf Ihrem Smartphone/Mobiltelefon.

Wenn die Eingabe eines PIN-Codes erforderlich ist, geben Sie den PIN-Code („0000“) ein.

-  erscheint, wenn das Bluetooth-Smartphone angeschlossen ist.

Trennen des Geräts

- Schalten Sie die Bluetooth-Funktion auf Ihrem Smartphone/Mobiltelefon aus.
- Schalten Sie das Zündschloss aus.

Telefonanrufe annehmen

- 1 Berühren Sie .

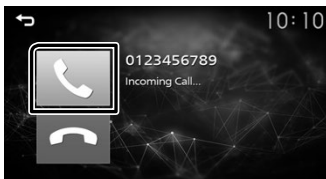





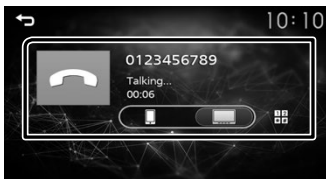

- : Lehnen Sie einen eingehenden Anruf ab.

Bedienvorgänge während eines Anrufs



Auflegen

- 1 2   
- Durch Berührung der entsprechenden Touchkeys auf dem Bildschirm können Sie Wahlöne festlegen.
- Berühren Sie , um das Fenster zu schließen.

- 1  
- Wechselt die ausgegebene Gesprächsstimme zwischen Smartphone/Mobiltelefon und Lautsprecher um.

- Hörerlautstärke einstellen
Drücken Sie die <+>- oder <->-Taste.

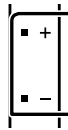



Telefonanrufe tätigen

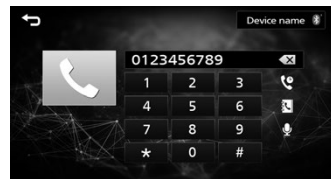



- 1 Drücken Sie die -Taste.
- 2 Berühren Sie [Phone].
- 3 Siehe nachfolgende Tabelle für jeweilige Betriebsmethode.





Anruf durch Eingabe einer Telefonnummer

- 1) Geben Sie eine Telefonnummer mittels Zifferntasten ein.
- 2) Berühren Sie .
Einen Anruf durchführen
- Berühren Sie , um den letzten Eintrag zu löschen.

Anruf tätigen mittels Anruflisten

- 1) Berühren Sie .
- 2) Berühren Sie  (Eingehende Anrufe),  (Abgehende Anrufe),  (Verpasste Anrufe).
- 3) Wählen Sie die Telefonnummer von der Liste.
Einen Anruf durchführen

Anruf tätigen mittels Telefonbuch

- 1) Berühren Sie .
- 2) Wählen Sie den Namen von der Liste.
Einen Anruf durchführen
- : Aktualisiert das Telefonbuch. Berühren Sie diese Schaltfläche, nachdem Sie eine Änderung im Telefonbuch Ihres Smartphones/Mobiltelefons vorgenommen haben.

Wiedergabe mit einem Bluetooth-Audiogerät

1 Drücken Sie die <🏠>-Taste.

2 Berühren Sie [BT Audio].

📱 Quellensteuerungsbildschirm



1 Zeigt die Information zur aktuellen Datei an.

2 Wiedergabezeit/Dateinummer
Wiedergabezeitleiste: Zur Bestätigung der aktuellen Wiedergabeposition

- 3 [🔍]: Wählt den Zufallswiedergabemodus aus.
[🔄]: Wählt den Wiederholungswiedergabemodus aus.
[▶], [⏸]: Wiedergabe oder Pause.
[⏪], [⏩]: Sucht den vorigen/nächsten Inhalt. Für schnellen Vorlauf oder schnellen Rücklauf anhaltend drücken.
[🔍]: Sucht die Datei. (S.43)

📎 HINWEIS

- Die Funktionen und Anzeigen können je nach ihrer Verfügbarkeit auf dem angeschlossenen Gerät abweichen.

📱 Einen Inhalt in einer Liste auswählen

1 Berühren Sie [🔍].

2 Drücken Sie auf die gewünschte Option.

Wenn Sie eine Kategorie berühren, werden ihre Inhalte angezeigt.

3 Gewünschtes Element der Liste drücken.

Startet Wiedergabe.

- Berühren Sie [🏠], um in die obere Hierarchie zu gelangen.

📎 HINWEIS

- Wenn Sie [🏠] in der obersten Hierarchie berühren, erscheint der Quellensteuerungsbildschirm.

Installation

Vor der Installation

Vor der Installation dieses Geräts beachten Sie bitte die folgenden Vorsichtsmaßnahmen.

⚠️ WARNHINWEISE

- Verbinden Sie Zünddraht (rot) und Batteriekabel (gelb) mit dem Fahrzeugchassis (Erde), so könnte dies zu einem Kurzschluss führen, der ein Feuer entzündet. Schließen Sie diese Drähte nur an eine Stromquelle an, die durch den Sicherungskasten geführt wird.
- Zündkabel (rot) und Batteriekabel (gelb) dürfen nie ohne Einbindung einer Sicherung installiert werden. Zwischen Stromversorgung und Kabel muss immer eine Sicherung installiert sein.

⚠️ ACHTUNG

- Montieren Sie dieses Gerät in der Konsole Ihres Fahrzeugs.
Berühren Sie die Metallteile des Geräts während oder kurz nach der Benutzung nicht. Metallteile wie der Kühlkörper und das Gehäuse werden heiß.

📎 HINWEIS



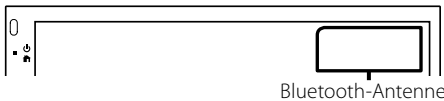

- Die Montage sowie die Verkabelung dieses Gerätes macht besondere Fähigkeiten und Erfahrung erforderlich. Überlassen Sie die Montage- und Verkabelungsarbeiten aus Sicherheitsgründen ausgewiesenem Fachpersonal.
- Betreiben Sie das Gerät ausschließlich mit 12-Volt-Gleichstrom und negativer Masseverbindung.
- Setzen Sie weder die Frontblende noch deren Etui direktem Sonnenlicht, extremer Wärme oder Luftfeuchtigkeit aus. Schützen Sie diese Teile außerdem vor Staub und Spritzwasser.
- Verwenden Sie für den Einbau ausschließlich die mitgelieferten Schrauben. Verwenden Sie ausschließlich die mitgelieferten Schrauben. Falsche Schrauben können das Gerät beschädigen.
- Wenn die Zündung Ihres Fahrzeuges keine ACC-Stellung hat, dann schließen Sie die Zündkabel an eine Stromquelle an, die mit dem Zündschlüssel ein- und ausgeschaltet werden kann. Wenn Sie das Zündkabel an eine Stromquelle mit konstanter Stromversorgung anschließen, wie z. B. Batteriekabel, kann dies die Batterie entleeren.
- Hat die Konsole eine Klappe, dann stellen Sie bei der Installation des Gerätes sicher, dass das Frontpanel beim Öffnen und Schließen nicht gegen die Klappe stößt.
- Wenn die Sicherung durchbrennt, überprüfen Sie zuerst, dass die Drähte sich nicht berühren und einen Kurzschluss verursachen. Ersetzen Sie dann die durchgebrannte Sicherung durch eine neue Sicherung mit den gleichen Nenngrößen.

Installation

- Isolieren Sie nicht angeschlossene Kabel mit Vinylband oder ähnlichem Material. Entfernen Sie nicht die Kapfen von den Enden nicht angeschlossener Kabel und Anschlüsse, damit keine Kurzschlüsse entstehen.
- Sichern Sie die Leitungen mit Kabelklemmen und umwickeln Sie die Drähte mit Vinylband, die in Kontakt mit Metallteilen kommen, um die Kabel zu schützen und Kurzschlüsse zu verhindern.
- Schließen Sie beide Pole der Lautsprecher an den Lautsprecherausgängen am Gerät an. Das Gerät kann beschädigt werden oder den Dienst versagen, wenn Sie die ⊖-Leiter zusammenführen oder über Metallteile des Fahrzeugs erden.
- Sind nur zwei Lautsprecher an das System angeschlossen, nutzen Sie die Anschlüsse entweder an den beiden vorderen oder an den beiden hinteren Ausgangsklemmen (nicht 1x vorne und 1x hinten anschließen). Wenn Sie zum Beispiel den ⊕-Stecker des linken Lautsprechers an eine Ausgangsbuchse für vorne anschließen, darf der ⊖-Stecker nicht an eine Ausgangsbuchse für hinten angeschlossen werden.
- Überprüfen Sie nach der Montage des Geräts, ob die Bremslichter, Blinker, Scheibenwischer usw. ordnungsgemäß funktionieren.
- Das Gerät so anbringen, dass der Montagewinkel 30 ° oder weniger beträgt.
- Bei der Installation des Gerätes im Fahrzeug dürfen Sie nicht zu sehr auf die Paneloberfläche drücken. Ansonsten könnte es zu Kratzern, Beschädigungen oder Fehlfunktionen kommen.
- Die Empfangsqualität wird u. U. durch metallische Gegenstände in der Nähe der Bluetooth-Antenne beeinträchtigt.

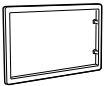

Für die Installation mitgeliefertes Zubehör

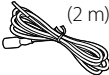
①	 x1	②	 x2
③	 x1	④ (3 m)	 x1
⑤	 (2 m) x1		

Installationsvorgang

- 1) Um einem Kurzschluss vorzubeugen, ziehen Sie bitte den Schlüssel aus dem Zündschloss und trennen Sie die ⊖-Klemme der Batterie ab.
- 2) Schließen Sie die Eingangs- und Ausgangskabel jedes Gerätes richtig an.
- 3) Schließen Sie den ISO-Anschluss am Gerät an.
- 4) Bauen Sie das Autoradio in Ihrem Fahrzeug ein.
- 5) Schließen Sie die ⊖-Klemme der Batterie wieder an.
- 6) Drücken Sie die Reset-Taste.

Installation des Geräts

Nichtjapanische Autos

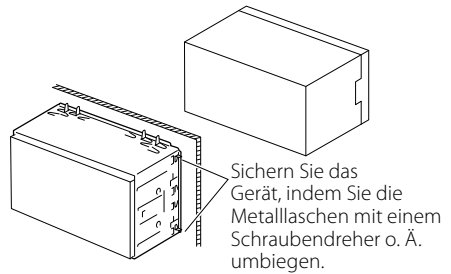

HINWEIS

- Stellen Sie sicher, dass das Gerät fest sitzt. Falls das Gerät nicht fest sitzt, können Fehlfunktionen (beispielsweise Sprünge bei der Wiedergabe) auftreten.

Ziertafel

- 1) Bringen Sie das Zubehör ① am Gerät an.

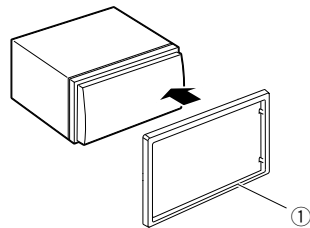

Installation

■ Mikrofoneinheit

- 1) Überprüfen Sie die Einbauposition des Mikrofons (Zubehör ④).
- 2) Säubern Sie die Installationsfläche.
- 3) Entfernen Sie die Schutzfolie vom Mikrofon (Zubehör ④) und kleben Sie das Mikrofon an die unten gezeigte Stelle.
- 4) Verlegen Sie das Mikrokabel bis zum Gerät und befestigen Sie es an mehreren Punkten mit Klebeband oder Ähnlichem.
- 5) Richten Sie die Richtung des Mikrofons (Zubehör ④) auf den Fahrer aus.

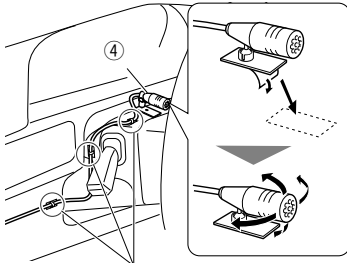

Befestigen Sie das Kabel mit handelsüblichem Klebeband.

🔧 HINWEIS

- Tauschen Sie bei Bedarf die Clips aus.

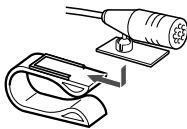

■ Entfernen der Ziertafel

- 1) Nutzen Sie den Entnahmeschlüssel (Zubehör ③), um die vier Laschen auszuhebeln (zwei am linken Teil, zwei am rechten Teil).

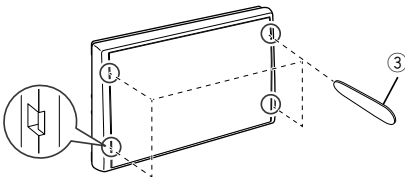

- 2) Ziehen Sie die Zierplatte nach vorn.

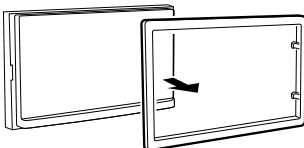

■ Ausbauen des Geräts

- 1) Entfernen Sie wie unter Schritt 1 von „Entfernen der Ziertafel“ beschrieben die Ziertafel.
- 2) Führen Sie den Entnahmeschlüssel (Zubehör ②) tief in den Schlitz ein, wie abgebildet. (Der vorstehende Teil an der Spitze des Entnahmeschlüssels muss zum Gerät zeigen.)

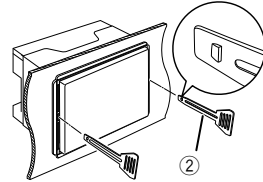

- 3) Wenn der Entnahmeschlüssel eingerastet ist, führen Sie den anderen Entnahmeschlüssel in den Schlitz ein.

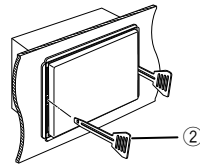

- 4) Ziehen Sie das Gerät halb heraus.

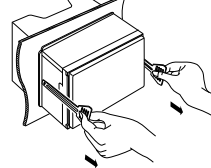

🔧 HINWEIS

- Gehen Sie vorsichtig vor, um sich nicht an den Vorsprüngen des Entnahmewerkzeugs zu verletzen.
- 5) Umfassen Sie das Gerät mit beiden Händen und ziehen Sie es vorsichtig heraus, damit es nicht herunterfällt.

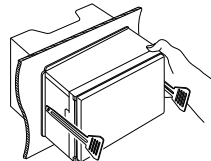

Installation

■ Anschließen der Kabel an die Anschlüsse

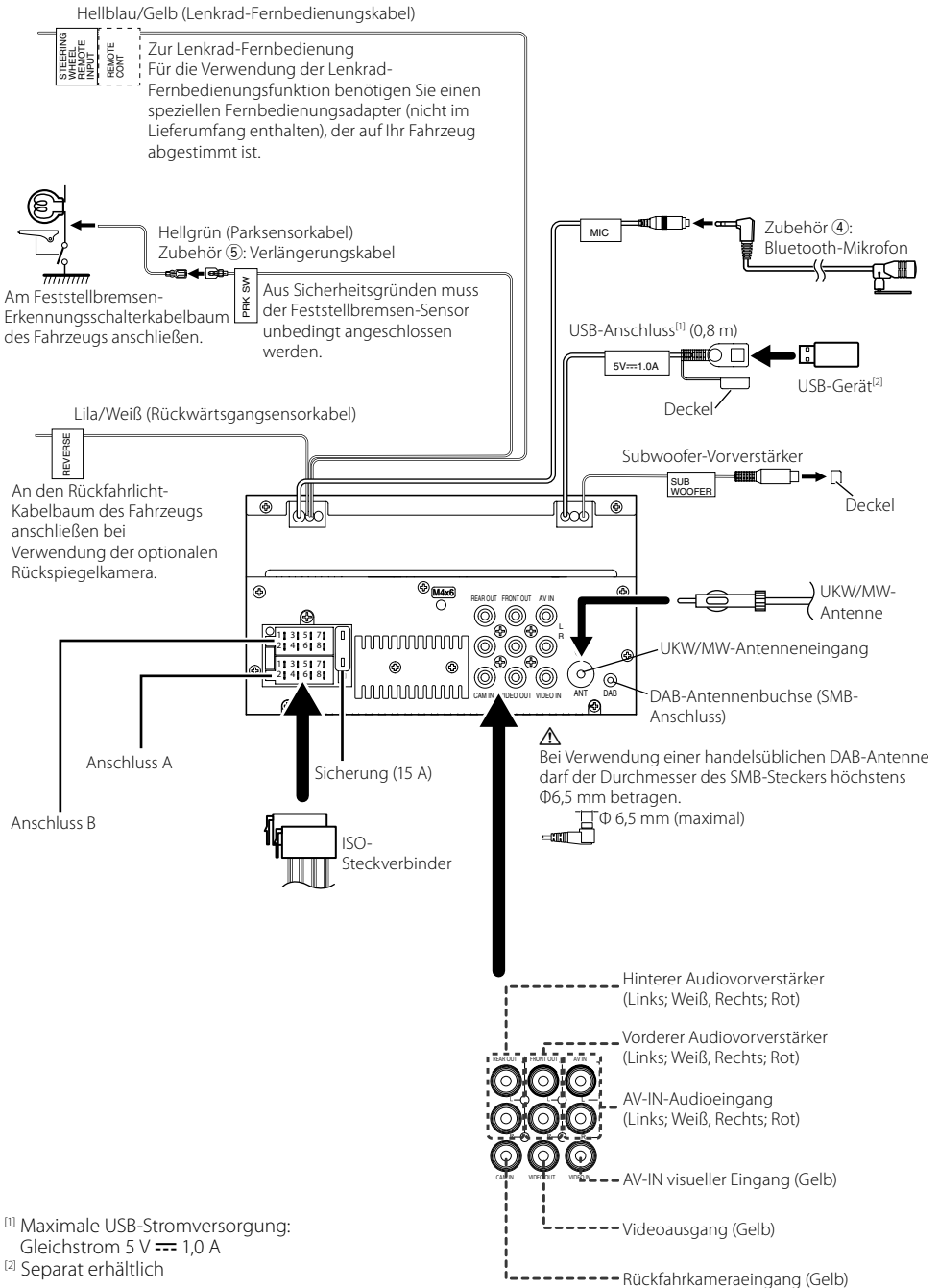

Installation

■ Funktionsanleitung für den Kabelbaumanschluss

Stift	Farbe und Funktion	
A-4	Gelb	Batterie
A-5	Blau/Weiß ^[1]	Stromsteuerung
A-7	Rot	Zündung (ACC)
A-8	Black	Erdungsanschluss (Masse)
B-1/B-2	Lila (+)/Lila/Schwarz (-)	Hinten rechts
B-3/B-4	Grau (+)/Grau/Schwarz (-)	Vorne rechts
B-5/B-6	Weiß (+)/Weiß/Schwarz (-)	Vorne links
B-7/B-8	Grün (+)/Grün/Schwarz (-)	Hinten links

^[1] Max. 150 mA, 12 V

- Lautsprecherimpedanz: 4-8 Ω

⚠ ACHTUNG

Überprüfen Sie die folgende Bedingung, bevor Sie die handelsüblichen ISO-Stecker an das Gerät anschließen:

- Überprüfen Sie, ob die Stiftbelegung des Steckers mit dem JVC-Gerät übereinstimmt.
- Achten Sie besonders auf das Stromkabel.
- Wenn das Batteriekabel und das Zündkabel nicht übereinstimmen, tauschen Sie sie entsprechend aus.
- Verwenden Sie eine handelsübliche Schnittstelle, wenn Ihr Auto über kein Zündkabel verfügt.

■ Anschluss eines iPods/iPhones/Android-Geräts

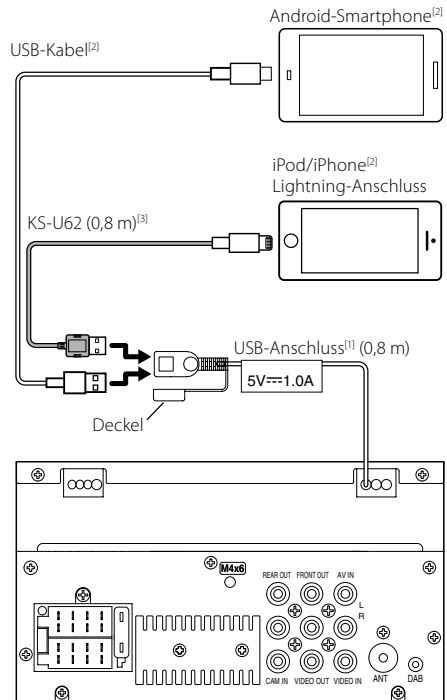

^[1] Maximale USB-Stromversorgung:
Gleichstrom 5 V --- 1,0 A

^[2] Separat erhältlich

^[3] Optionales Zubehör

Wissenswertes über dieses Gerät

Weitere Informationen

Verwendbare USB-Geräte

Dieses Gerät kann MPEG1/MPEG2/MPEG4/H.264/MKV/MP3/WMA/AAC/WAV/FLAC/OGG-Dateien wiedergeben, die auf einem USB-Massenspeicher gespeichert sind.

- Dateisystem: FAT16/FAT32

HINWEIS

- Wird das USB-Gerät an dieses Gerät angeschlossen, kann es durch das USB-Kabel aufgeladen werden.
- Bringen Sie das USB-Gerät an einer Stelle an, die einer sicheren Fahrweise nicht hinderlich ist.
- Sie können kein USB-Gerät über einen USB-Hub und einen Mehrfach-Kartenleser anschließen.
- Erstellen Sie Sicherheitskopien der Audiodateien, die in diesem Gerät verwendet werden. Je nach den Betriebsbedingungen des USB-Geräts werden diese Dateien möglicherweise gelöscht. Für Schäden durch gelöschte Speicherdaten wird keine Haftung übernommen.
- Im Lieferumfang dieses Geräts ist kein USB-Gerät enthalten. Sie müssen ein handelsübliches USB-Gerät kaufen.
- Setzen Sie den Deckel auf den USB-Anschluss auf, wenn er nicht verwendet wird.

Abspielbare Audiodateien

Audioformat	Erweiterung
MP3	.mp3
WMA	.wma
AAC-LC	.m4a, .aac
Linear-PCM (WAVE)	.wav
FLAC	.flac
Vorbis	.ogg

- Dieses Gerät kann den ID3-Tag der Version 1.0/1.1/2.2/2.3/2.4 (für MP3) anzeigen.

HINWEIS

- Mit DRM gesicherte WMA- und AAC-Dateien können nicht abgespielt werden.
- Auch wenn Audiodateien mit den oben genannten Standards übereinstimmen, kann es möglicherweise sein, dass sie nicht abgespielt werden - je nach Art oder Zustand des Datenträgers oder Geräts.

Geeignete Videodateien

Videoformat	Erweiterung
MPEG-1	.mpg, .mpeg
MPEG-2	.mpg, .mpeg
MPEG-4	.mp4, .avi
H.264/MPEG-4 AVC	.mp4, .mkv, .avi, .flv, .f4v, .ts
MKV	.mkv

Hinweis zu den Spezifikationen

Bluetoothbereich

Frequenz

: 2,402 – 2,480 GHz

Ausgangsleistung

: +8 dBm (DURCHSCHN.), Leistungsklasse 1

Allgem.

Lautsprecherimpedanz

: 4 – 8 Ω

Betriebsspannung

: 12 V DC-Autobatterie

Urheberrechte

- Die Bluetooth® Wortmarke und Logos sind eingetragene Markenzeichen der Bluetooth SIG, Inc. und jegliche Verwendung dieser Marken durch die JVCKENWOOD Corporation geschieht unter Lizenz. Andere Warenzeichen und Handelsmarken sind Eigentum der jeweiligen Inhaber.
- Use of the Made for Apple badge means that an accessory has been designed to connect specifically to the Apple product(s) identified in the badge and has been certified by the developer to meet Apple performance standards. Apple is not responsible for the operation of this device or its compliance with safety and regulatory standards. Please note that the use of this accessory with an Apple product may affect wireless performance.
- Apple, iPhone, iPod, iPod touch, and Lightning are trademarks of Apple Inc., registered in the U.S. and other countries.
- Microsoft and Windows Media are either registered trademarks or trademarks of Microsoft Corporation in the United States and/or other countries.
- THIS PRODUCT IS LICENSED UNDER THE MPEG-4 VISUAL PATENT PORTFOLIO LICENSE FOR THE PERSONAL AND NON-COMMERCIAL USE OF A CONSUMER FOR (i) ENCODING VIDEO IN COMPLIANCE WITH THE MPEG-4 VISUAL STANDARD ("MPEG-4 VIDEO") AND/OR (ii) DECODING MPEG-4 VIDEO THAT WAS ENCODED BY A CONSUMER ENGAGED IN A PERSONAL AND NON-COMMERCIAL ACTIVITY AND/OR WAS OBTAINED FROM A VIDEO PROVIDER LICENSED BY MPEG LA TO PROVIDE MPEG-4 VIDEO. NO LICENSE IS GRANTED OR SHALL BE IMPLIED FOR ANY OTHER USE. ADDITIONAL INFORMATION INCLUDING THAT RELATING TO PROMOTIONAL, INTERNAL AND COMMERCIAL USES AND LICENSING MAY BE OBTAINED FROM MPEG LA, LLC. SEE [HTTP://WWW.MPEGLA.COM](http://www.MPEGLA.COM).
- THIS PRODUCT IS LICENSED UNDER THE AVC PATENT PORTFOLIO LICENSE FOR THE PERSONAL USE OF A CONSUMER OR OTHER USES IN WHICH IT DOES NOT RECEIVE REMUNERATION TO (i) ENCODE VIDEO IN COMPLIANCE WITH THE AVC STANDARD ("AVC VIDEO")

Wissenswertes über dieses Gerät

AND/OR (j) DECODE AVC VIDEO THAT WAS ENCODED BY A CONSUMER ENGAGED IN A PERSONAL ACTIVITY AND/OR WAS OBTAINED FROM A VIDEO PROVIDER LICENSED TO PROVIDE AVC VIDEO. NO LICENSE IS GRANTED OR SHALL BE IMPLIED FOR ANY OTHER USE. ADDITIONAL INFORMATION MAY BE OBTAINED FROM MPEG LA, L.L.C. SEE [HTTP://WWW.MPEGLA.COM](http://www.mpegla.com)

- libFLAC

Copyright (C) 2000-2009 Josh Coalson

Copyright (C) 2011-2013 Xiph.Org Foundation

- Redistribution and use in source and binary forms, with or without modification, are permitted provided that the following conditions are met:
- Redistributions of source code must retain the above copyright notice, this list of conditions and the following disclaimer.
- Redistributions in binary form must reproduce the above copyright notice, this list of conditions and the following disclaimer in the documentation and/or other materials provided with the distribution.

Neither the name of the Xiph.org Foundation nor the names of its contributors may be used to endorse or promote products derived from this software without specific prior written permission.

THIS SOFTWARE IS PROVIDED BY THE COPYRIGHT HOLDERS AND CONTRIBUTORS "AS IS" AND ANY EXPRESS OR IMPLIED WARRANTIES, INCLUDING, BUT NOT LIMITED TO, THE IMPLIED WARRANTIES OF MERCHANTABILITY AND FITNESS FOR A PARTICULAR PURPOSE ARE DISCLAIMED. IN NO EVENT SHALL THE FOUNDATION OR CONTRIBUTORS BE LIABLE FOR ANY DIRECT, INDIRECT, INCIDENTAL, SPECIAL, EXEMPLARY, OR CONSEQUENTIAL DAMAGES (INCLUDING, BUT NOT LIMITED TO, PROCUREMENT OF SUBSTITUTE GOODS OR SERVICES; LOSS OF USE, DATA, OR PROFITS; OR BUSINESS INTERRUPTION) HOWEVER CAUSED AND ON ANY THEORY OF LIABILITY, WHETHER IN CONTRACT, STRICT LIABILITY, OR TORT (INCLUDING NEGLIGENCE OR OTHERWISE) ARISING IN ANY WAY OUT OF THE USE OF THIS SOFTWARE, EVEN IF ADVISED OF THE POSSIBILITY OF SUCH DAMAGE.

- libogg

Copyright (c) 2002, Xiph.org Foundation

Redistribution and use in source and binary forms, with or without modification, are permitted provided that the following conditions are met:

- Redistributions of source code must retain the above copyright notice, this list of conditions and the following disclaimer.
- Redistributions in binary form must reproduce the above copyright notice, this list of conditions and the following disclaimer in the documentation and/or other materials provided with the distribution.
- Neither the name of the Xiph.org Foundation nor the names of its contributors may be used to endorse or promote products derived from this software without specific prior written permission.

THIS SOFTWARE IS PROVIDED BY THE COPYRIGHT HOLDERS AND CONTRIBUTORS "AS IS" AND ANY EXPRESS OR IMPLIED WARRANTIES, INCLUDING, BUT NOT LIMITED TO, THE IMPLIED WARRANTIES OF MERCHANTABILITY AND FITNESS FOR A PARTICULAR PURPOSE ARE DISCLAIMED. IN NO EVENT SHALL THE FOUNDATION OR CONTRIBUTORS BE LIABLE FOR ANY DIRECT, INDIRECT, INCIDENTAL, SPECIAL, EXEMPLARY, OR CONSEQUENTIAL DAMAGES (INCLUDING, BUT NOT LIMITED TO, PROCUREMENT OF SUBSTITUTE GOODS OR SERVICES; LOSS OF USE, DATA, OR PROFITS; OR BUSINESS INTERRUPTION) HOWEVER CAUSED AND ON ANY THEORY OF LIABILITY, WHETHER IN CONTRACT, STRICT LIABILITY, OR TORT (INCLUDING NEGLIGENCE OR OTHERWISE) ARISING IN ANY WAY OUT OF THE USE OF THIS SOFTWARE, EVEN IF ADVISED OF THE POSSIBILITY OF SUCH DAMAGE.

Entsorgung von gebrauchten elektrischen und elektronischen Geräten und Batterien (anzuwenden in EU-Ländern mit einem separaten Sammelsystem für solche Geräte)

Das Symbol (durchgestrichene Mülltonne) auf dem Produkt oder seiner Verpackung weist darauf hin, dass dieses Produkt nicht als normaler Haushaltsabfall behandelt werden darf, sondern an einer Annahmestelle für das Recycling von elektrischen und elektronischen Geräten und Batterien abgegeben werden muss.

Alte elektrische und elektronische Geräte müssen in einer Anlage recycelt werden, die für den Umgang mit diesen Artikeln und dem Begleitabfall geeignet sind. Unsachgemäße oder falsche Entsorgung gefährden Umwelt und Gesundheit.

Weitere Informationen über das Recycling dieses Produktes erhalten Sie von Ihrer Gemeinde oder den kommunalen Entsorgungsbetrieben.

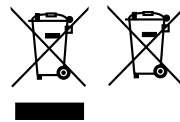

Inhoud

Voor ingebruikname.....	50
De handleiding gebruiken.....	50
Vorzorgsmaatregelen	50
Aan de Slag.....	51
Klokinstellingen	51
Basisinstellingen	52
Functies van de knoppen op het voorpaneel.....	52
Basisbediening.....	52
Startscherm	52
Bronbedieningsscherm.....	52
Digitale radio.....	53
Basisbediening digitale radio	53
Digitale radio instellen	53
Tuner.....	54
Basisbediening van de Tuner.....	54
Installatie van de afstemmer.....	54
USB	55
Voorbereiding	55
Weergaveopties.....	55
iPod/iPhone	56
Voorbereiding	56
Weergaveopties.....	56
Externe Componenten.....	57
Externe audio/video-spelers gebruiken.....	57
Achteruitzichtcamera	57
Audio regelen.....	57
Algemene audio regelen.....	57
Bluetooth	58
Registreer uw mobiele telefoon bij het toestel.....	58
Ontvangen van een telefoongesprek.....	58
Voer een telefoongesprek uit	58
Bluetooth-audioapparaat afspelen.....	59
Installatie.....	59
Vóór de installatie	59
De unit installeren	60
Informatie over dit toestel.....	64
Meer informatie	64
Opmerking voor specificaties	64
Auteursrechten.....	64

- Raadpleeg voor gedetailleerde bedieningen en informatie de INSTRUCTIEHANDLEIDING op de volgende website:

<<https://www.jvc.net/cs/car/>>



De handleiding gebruiken

- De panelen die in deze handleiding worden weergegeven, zijn voorbeelden om een duidelijke uitleg van de werking te kunnen geven. Om die reden kunnen de panelen afwijken van de werkelijke panelen.
- Tijdens bedieningsprocedures geeft de vorm van de haken aan welke toets of knop u moet bedienen.
 - < >: Geeft de naam van de paneelknoppen aan.
 - []: Geeft de naam van de toetsen aan

Voor ingebruikname

Vorzorgsmaatregelen

⚠ WAARSCHUWING

■ **Neem de volgende voorzorgsmaatregelen om persoonlijk letsel of brand te voorkomen:**

- Om kortsluiting te voorkomen plaats u nooit metalen voorwerpen (zoals munten of metalen gereedschappen) in het toestel of laat u deze in het toestel achter.
- Kijk niet naar het scherm of richt uw ogen niet op het scherm als u langere tijd aan het rijden bent.
- Raadpleeg uw JVC-dealer als u tijdens de installatie problemen ondervindt.

■ **Vorzorgsmaatregelen voor het gebruik van het toestel**

- Neem wanneer u optionele toebehoren aanschaft contact op met uw JVC-dealer om te controleren of deze optionele toebehoren met uw model en in uw regio functioneren.
- De functie Radio Data System of Radio Broadcast Data System werkt niet als deze functie niet wordt ondersteund door een te ontvangen radiostation.

■ **De monitor beschermen**

- Om te voorkomen dat de monitor beschadigd raakt, mag u de monitor niet bedienen met een balpen of een soortgelijk hulpmiddel met scherpe punt.

■ **Het toestel reinigen**

Als er vlekken op het voorpaneel van dit toestel zitten, veeg deze er dan met een droge, zachte doek, zoals een siliconendoekje, van af. Als er hardnekkige vlekken op het voorpaneel zitten, veeg deze er dan eerst met een met neutraal reinigingsmiddel bevochtigde doek en vervolgens met een schone, zachte, droge doek van af.

⚠ VOORZICHTIG

- Als u reinigingsspray rechtstreeks op het toestel spuit, kunnen de mechanische onderdelen ervan beschadigd raken. Als u het voorpaneel met een harde doek of met een vluchtige vloeistof zoals thinner of alcohol afveegt, kunnen er krassen ontstaan of wordt opgedrukte tekst gewist.

■ **Uw toestel resetten**

Als het toestel of het aangesloten toestel niet naar behoren werkt, moet het toestel worden gereset.

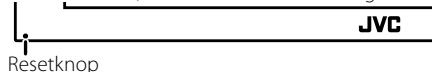

Dit symbool op het product betekent dat er belangrijke bedienings- en onderhoudsinstructies in deze handleiding voorkomen. Lees de instructies in deze handleiding zorgvuldig door.

Aan de Slag

1 Draai de contactsleutel van uw auto in de stand ACC.

Het toestel wordt ingeschakeld.

2 Druk op de knop.

3 Raak [



4 Raak de corresponderende toets aan en stel de waarde in.

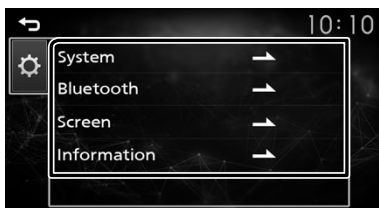

[System]

[Beep Tone]

Activeert of deactiveert het toetsgeluid. „ON“ (AAN) (Standaard), „OFF“ (UIT)

[Language]

Selecteer de taal die wordt gebruikt voor het regelscherm en de in te stellen opties. De standaardinstelling is „English“ (Engels).

[Time/Date]

Pas de kloktijd aan. (P.51)

[Clock Mode]

Selecteer het formaat van de tijdweergave. [12hr]/[24hr] (standaard)

[Parking Guidelines]

U kunt parkeerriichtlijnen weergeven om gemakkelijker parkeren in te schakelen wanneer u de versnelling om de achteruit-positie (R) zet. De standaardinstelling is „ON“ (aan).

[Guidelines SETUP]

Als u [ON] selecteert voor [Parking Guidelines], kunt u de parkeerriichtlijnen aanpassen.

[System Reset]

Raak [System Reset] aan en raak dan [YES] aan om alle instellingen terug te zetten naar de oorspronkelijke standaardinstellingen.

[Bluetooth]

Geeft het Bluetooth-instellingscherm weer.

[Screen]

[Dimmer]

Selecteer de dimmerstand. „High“ (standaard)/„Mid“/„Low“

[Demo]

Selecteer de demonstratiestand. De standaardinstelling is „ON“ (aan).

[Information]

Geeft de softwareversie van dit apparaat weer.

5 Raak [

Klokinstellingen

Synchroniseren van de kloktijd met FM RDS

Activeer [RDS Clock Sync] (RDS Kloksynchronisatie).

Zie *Installatie van de afstemmer (P.54)*.

De klok handmatig aanpassen

OPMERKING

- Deactiveer [RDS Clock Sync] voordat u de klok aanpast.

1 Druk op de knop.

2 Raak [

3 Raak [System] aan.

4 Raak [Time/Date] aan.

Klokkscherm verschijnt.

5 Raak [] of [] aan om de kloktijd in te stellen.



6 Raak [

Basisinstellingen

Funcies van de knoppen op het voorpaneel

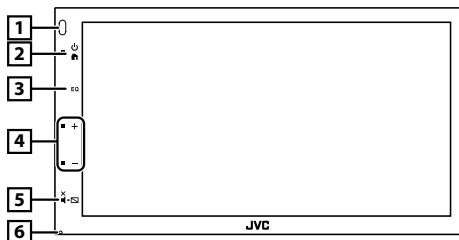

1 Sensor op afstand

- Ontvangt het bedieningssignaal op afstand.

2 (HOME)

- Geeft het START-scherm weer. **(P.52)**
- Als de knop 1 seconde wordt ingedrukt, wordt het toestel uitgeschakeld.
- Als het toestel is uitgeschakeld, wordt het ingeschakeld.

3 EQ

- Geeft het Geluidscherm weer.* **(P.57)**
- * Het Geluidscherm wordt niet weergegeven tijdens het SETUP-scherm of op het lijtscherm, enz.

4 +, - (Volume)

- Regelt het volume. Het volume gaat tot niveau 20 wanneer u [+] ingedrukt houdt.

5 (MUTE, Weergave uit)

- Dempt/herstelt het geluid.
- Als de knop 1 seconde wordt ingedrukt, wordt het scherm uitgeschakeld.
- Als het scherm is uitgeschakeld, raakt u het scherm aan om het scherm in te schakelen.

6 Reset

- Als de eenheid of de hiermee verbonden eenheid niet correct werkt, dan zal de eenheid terugkeren naar de fabrieksinstellingen wanneer er op deze knop wordt gedrukt.

Basisbediening

Het inschakelen van de stroom

1 Druk op de knop.



Uitschakelen van de stroom

1 Druk in en houd de -knop ingedrukt.

Startscherm

1 Druk op de knop.

START-scherm verschijnt.



1 Klokweergave

2 Schakelt over naar de radio-uitzending. **(P.54)**

3 [USB]

Speelt bestanden af op een USB-apparaat. **(P.55)**

[iPod]

Speelt een iPod/iPhone af. **(P.56)**

- Wanneer de iPod/iPhone is verbonden.

[Mirroring]

Geeft het Spiegelenscherm weer.

- Wanneer er een Android-apparaat waarop de app „Mirroring OB for JVC“ is geïnstalleerd wordt aangesloten.

4 Schakelt naar een extern component aangesloten op de AV-IN-aansluiting. **(P.57)**

5 Geeft het scherm Hands Free weer. **(P.58)**

6 Afspelen van een Bluetooth-audiospeler. **(P.59)**

7 Schakelt over naar de digitale radio-uitzending. **(P.53)**

8 Geeft het INSTELLINGEN-scherm weer. **(P.51)**

Bronbedieningsscherm



1 : Keert terug naar het vorige scherm.

: Geeft het Geluidscherm weer. **(P.57)**

Digitale radio

Basisbediening digitale radio

- 1 Druk op de knop.
- 2 Raak [Digital Radio] aan.

Bronbedieningsscherm

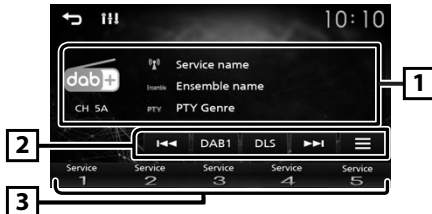

- 1 Informatie over de huidige zender wordt weergegeven:
Servicenaam, ensemblenaam, PTY-genre, kanaal
- 2 **[DAB]**: Schakelt over van de voorinstelling van de digitale radio.
„DAB1“, „DAB2“, „DAB3”
[DLS]: Het scherm Dynamische labelsegment weergeven
[]: Selecteer een ensemble, service en component.
[]: Geeft het instellingsscherm voor Digitale radio weer. **(P.53)**
- 3 Roept de opgeslagen service op.
Als deze toets 2 seconden wordt aangeraakt, wordt de huidige zender in het geheugen opgeslagen.

Sla een zender op

U kunt de huidige service in het geheugen opslaan.

- 1 **Stem af op een zender die u in het geheugen wilt instellen.**
- 2 **Houd het [#] (#:1-5) waaronder u de zender wilt opslaan ingedrukt.**

Selecteer een opgeslagen service

- 1 Raak [#] (#:1-5) aan.

Digitale radio instellen

- 1 Raak [] aan.
- 2 Stel de verschillende items als volgt in.



[Service List]

Geeft het Servicelijst-scherm weer.

- []: Raak aan en raak vervolgens [Yes] aan voor de meest recente zenderlijst.

[TI]

Schakelt automatisch naar de verkeersinformatie wanneer er een verkeersbericht wordt uitgezonden.
„ON” (AAN), „OFF” (UIT) (Standaard)

[PTY]

Zoekt een programma aan de hand van het programmatype.

[Priority]

Als de ontvangst van een door digitale radio geleverde dienst slecht wordt en dezelfde dienst door een Radio Data System wordt geleverd, wordt er automatisch geschakeld naar Radio Data System.
„ON” (AAN), „OFF” (UIT) (Standaard)

[Announcement Select]

Schakelt over naar de aankondigingsdienst.

[Related Service]

Wanneer u AAN selecteert, schakelt de unit over naar een gerelateerde service (indien deze bestaat) wanneer een DAB-servicenetwerk niet beschikbaar is. De standaardwaarde is „OFF”.

[Antenna Power]

Stelt de voeding in op de antenne voor digitale radio. Stel deze optie in op „ON” als de antenne voor digitale radio is uitgerust met een versterker. De standaardinstelling is „ON” (aan).

- 3 Raak [] aan.

Tuner

Basisbediening van de Tuner

- 1 Druk op de knop.
- 2 Raak [Tuner] aan.

Bronbedieningsscherm

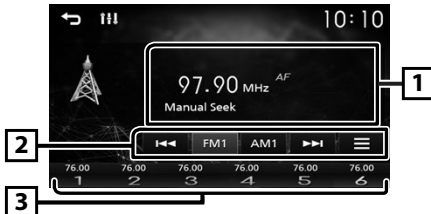

- 1 Geeft de informatie van de huidige zender weer: PS-naam, Frequentie, PTY-genre, indicatoren
- 2 **[FM]**: Wisselt de FM band. „FM1“, „FM2“, „FM3”
[AM]: Wisselt de AM band. „AM1“, „AM2”
[>]: Stemt automatisch af op een zender met goed ontvangst.
[]: Geeft het Tuner SETUP-scherm weer. (P.54)
- 3 Roept de opgeslagen zender op. Als deze toets 2 seconden wordt aangeraakt, wordt de huidige zender in het geheugen opgeslagen.

Automatisch geheugen

U kunt 6 zenders vooraf instellen voor de huidige band (FM1/FM2/FM3/AM1/AM2).

- 1 Raak **[FM]** of **[AM]** aan om de band te selecteren.
- 2 Raak **[]** aan.
- 3 Raak **[Auto Store]** aan.
De lokale zenders met de sterkste signalen worden automatisch gevonden en opgeslagen.

Handmatig geheugen

U kunt de huidig ontvangen zender in het geheugen opslaan.

- 1 Stem af op een zender die u vooraf wilt instellen.
- 2 Raak aan en houdt **[#]** (**#**:1-6) vast waarin u de zender wilt opslaan.

Oproepen van voorkeuzenders

- 1 Raak **[#]** (**#**:1-6) aan.

Installatie van de afstemmer

- 1 Raak **[]** aan.
- 2 Stel de verschillende items als volgt in.

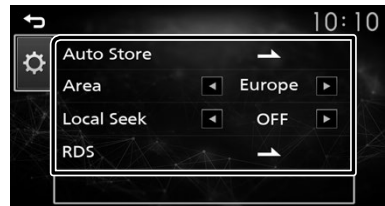

[Auto Store]

Zoekt automatisch naar de 6 stations met de sterkste signalen voor de geselecteerde band en slaat deze op.

„Auto Store” verschijnt.

[Local Seek]

Stemt alleen af op de zenders met voldoende signaalsterkte. (**LOC** indicator licht op.)

„ON” (AAN), „OFF” (UIT) (Standaard)

[RDS]*1

Geeft het RDS-instellingenscherf weer.

[AF]

Wanneer de ontvangstkwaliteit slecht is, wordt automatisch overgeschakeld op de zender die hetzelfde programma uitzendt in hetzelfde Radio Data System-netwerk.

„ON” (AAN) (Standaard), „OFF” (UIT)

[TA]

Schakelt automatisch naar de verkeersinformatie wanneer er een verkeersbericht wordt uitgezonden. (**TI** indicator gaat branden.)

„ON” (AAN), „OFF” (UIT) (Standaard)

[RDS Clock Sync]

Het synchroniseren van de tijdgegevens van de zender van het Radio-datasysteem en de klok van deze eenheid.

„ON” (AAN) (Standaard), „OFF” (UIT)

[PTY]

Selecteer een programmatype.

[PTY Seek]

Zoekt een programma aan de hand van het programmatype.

*1 Alleen FM

- 3 Raak **[]** aan.

USB

Vorbereiding

■ Een USB-apparaat aansluiten

- 1 Verwijder de dop van het USB-aansluitpunt.
- 2 Sluit het USB-apparaat via de USB-kabel aan.

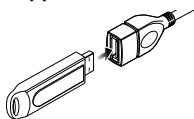

Het toestel leest de disk en het afspelen begint.

■ Het USB-apparaat loskoppelen:

- 1 Druk op de $\langle \text{home} \rangle$ knop.
- 2 Raak een andere bron dan [USB] aan.
- 3 Ontkoppel het USB-apparaat.

■ Bruikbaar USB-apparaat

Dit apparaat kan MPEG1/MPEG2/MPEG4/H.264/MKV/MP3/WMA/AAC/WAV/FLAC en OGC-bestanden die op een USB-geheugen zijn opgeslagen afspelen.

Weergaveopties

■ Regel de muziek op het bronregelscherm.



- 1 De omslag van het momenteel afgespeelde bestand wordt weergegeven.
- 2 Informatie over het huidige bestand wordt weergegeven.
- 3 Speelduur/bestandsnummer
Afspeeltijd balk: Voor bevestiging van huidige afspelerpositie.
- 4 []: Selecteert willekeurige afspelerstand.
[]: Selecteert repeatstand.
[], []: Speelt of pauzeert.
[], []: Zoekt de vorige/volgende inhoud.
Aangeraakt houden om snel vooruit of snel achteruit te gaan.
[]: Zoekt bestand. (P.55)

■ Voor het afspelen van Video

- 1 Wanneer de bedieningsknoppen niet worden weergegeven op het scherm, raak dan het scherm aan.

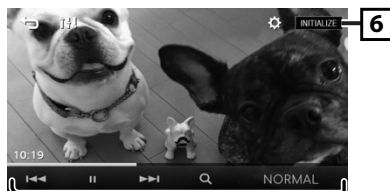

- 6 []: U kunt de beeldkwaliteit aanpassen in het videoscherm.
[INITIALIZE]: Om de aanpassing te wissen.
- 7 [], []: Speelt of pauzeert.
[], []: Zoekt de vorige/volgende inhoud.
Aangeraakt houden om snel vooruit of snel achteruit te gaan.
[]: Zoekt bestand. (P.55)
[NORMAL]/[16:9]/[4:3]: Selecteer een schermstand.

■ Een nummer op een lijst selecteren (Zoekt bestand)

- 1 Raak [] aan.
- 2 Selecteer of u wilt zoeken op audiobestanden [] of videobestanden [].
- 3 Raak [] aan om een niveau omhoog te gaan.
- 4 Raak de gewenste map aan.
Wanneer u een map aanraakt, wordt diens inhoud weergegeven.
• Raak [] aan om een niveau omhoog te gaan.
- 5 Raak het gewenste onderdeel in het inhoudsoverzicht aan.
Het afspelen begint.

OPMERKING

- Het bronbedieningsscherm verschijnt wanneer u [] aanraakt op het hoogste niveau.

iPod/iPhone

Voorbereiding

■ Aansluiten iPod/iPhone

- Voor Lightning aansluitingsmodellen: Gebruik USB-audiokabel voor iPod/iPhone—KS-U62 (optionele accessoire).
- Voor meer informatie over het aansluiten van iPod/iPhone, zie pagina 63.

1 Verwijder de dop van het USB-aansluitpunt.

2 Sluit de iPod/iPhone aan.

Het toestel leest de disk en het afspelen begint.

■ De iPod/iPhone loskoppelen

1 Druk op de <⏏> knop.

2 Raak een andere bron dan [iPod] aan.

3 Ontkoppel de iPod/iPhone.

■ Aansluitbare iPod/iPhone

De volgende modellen kunnen op dit toestel worden aangesloten.

Gemaakt voor

- | | | |
|------------------------------|---------------------|------------------|
| • iPhone 12 Pro Max | • iPhone 11 Pro Max | • iPhone 8 Plus |
| • iPhone 12 Pro | • iPhone 11 Pro | • iPhone 8 |
| • iPhone 12 | • iPhone 11 | • iPhone 7 Plus |
| • iPhone 12 mini | • iPhone XS Max | • iPhone 7 |
| • iPhone SE (2nd generation) | • iPhone XS | • iPhone SE |
| | • iPhone XR | • iPhone 6s Plus |
| | • iPhone X | • iPhone 6s |
| | | • iPhone 6 Plus |

📎 OPMERKING

- Als u muziek gaat afspelen nadat u de iPod hebt aangesloten, wordt eerst de muziek afgespeeld die door de iPod is afgespeeld.
- Plaats de dop op het USB-aansluitpunt wanneer u deze niet gebruikt.

Weergaveopties

■ Regel de muziek op het bronregelscherm.

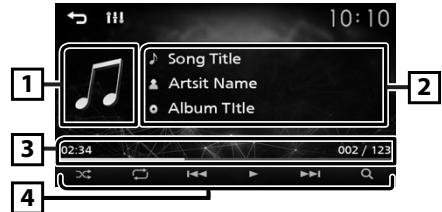

- 1 Illustraties (Worden weergegeven als het liedje illustraties bevat)
- 2 Informatie over het huidige bestand wordt weergegeven.
- 3 Speelduur/bestandsnummer
Afspeeltijd balk: Voor bevestiging van huidige afspelpositie.
- 4 [⏏]: Selecteert willekeurige afspelstand.
[⏮]: Selecteert repeatstand.
[▶], [⏸]: Speelt of pauzeert.
[◀], [▶]: Zoekt de vorige/volgende inhoud. Aangeraakt houden om snel vooruit of snel achteruit te gaan.
[🔍]: Zoekt naar inhoud. (P.56)

■ Selecteren van inhoud in een lijst

1 Raak [🔍] aan.

2 Raak het gewenste onderdeel aan.

Wanneer u een categorie aanraakt, wordt diens inhoud weergegeven.

3 Raak het gewenste onderdeel in het inhoudsoverzicht aan.

Het afspelen begint.

- Raak [⏏] aan om een niveau omhoog te gaan.

📎 OPMERKING

- Het bronbedieningsscherm verschijnt wanneer u [⏏] aanraakt op het hoogste niveau.

Externe Componenten **Audio regelen**

Externe audio/video-spelers gebruiken

Het afspeLEN begint

- 1 Koppel een extern component aan het AV-IN-ingangsaanluitpunt. (P.62)
- 2 Druk op de <Home> knop.
- 3 Raak [AV-IN] aan.
- 4 Zet het gekoppelde component aan en begin de bron af te spelen.

Voor het afspeLEN van Video

- 1 Wanneer de bedieningsknoppen niet worden weergegeven op het scherm, raak dan het scherm aan.

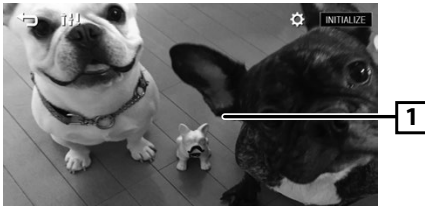

Achteruitzichtcamera

Om een achteruitkijkcamera te gebruiken, is de OMGEKEERD geleide koppeling nodig. Om een achteruitkijkcamera aan te sluiten. (P.62)

Het beeld van de achteruitkijkcamera weergeven

Het achteruitkijk-scherm wordt weergegeven wanneer u de versnelling schakelt naar de achteruitpositie (R).



- Om het waarschuwingsbericht te wissen, raakt u het scherm aan.

U kunt verschillende instellingen veranderen, zoals geluidbalans of subwooferniveau.

- 1 Druk op de <EQ>-knop.
- 2 Zie de tabel hieronder voor elke bedieningsmethode.



Algemene audio regelen

- 1 Druk op de <EQ>-knop.
- 2 Raak [Fader / Balance] aan.
- 3 Stel de verschillende items als volgt in.

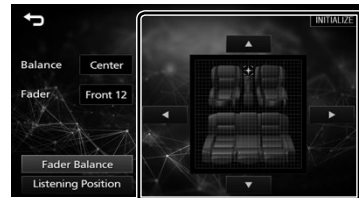

[Fader Balance]

Balance Pas de linker en rechter volumebalans aan.

[▶] [◀]
15 (rechts) tot 15 (links)

Fader Aanpassen van de voorste en achterste volumebalans.

[▲] [▼]
15 (voorkant) tot 15 (achterkant)

[INITIALIZE] Om de aanpassing te wissen.

Bluetooth

Registreer uw mobiele telefoon bij het toestel

U kunt uw Bluetooth-smartphone gebruiken als deze aan dit toestel is gekoppeld.

1 Zet de Bluetooth-functie op uw smartphone/mobiele telefoon aan.

2 Zoek de unit („KW-M27DBT“) vanaf uw smartphone/mobiele telefoon.

Als er een PIN-code is vereist, voert u de pincode („0000“) in.

-  verschijnt wanneer de Bluetooth-smartphone verbonden is.

Het apparaat ontkoppelen

- Zet de Bluetooth-functie op uw smartphone/mobiele telefoon uit.
- Zet het contactslot uit.

Ontvangen van een telefoongesprek

1 Raak  aan.

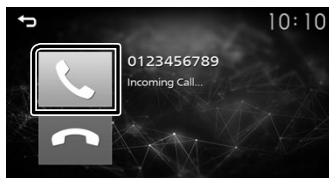

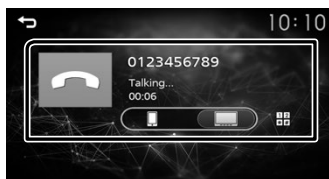

- : Wijs een inkomend telefoongesprek af.

Bediening tijdens een telefoongesprek



 Een telefoongesprek beëindigen

 U kunt tonen versturen door de gewenste toetsen op het scherm aan te raken.

- Raak  aan om het venster te sluiten.

 Schakelt de weergave van de stem tussen smartphone/mobiele telefoon en luidspreker.

- **Het volume van de ontvanger aanpassen**
Druk op de < + > of < - > knop.

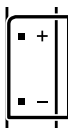

Voer een telefoongesprek uit



1 Druk op de  knop.

2 Raak  aan.

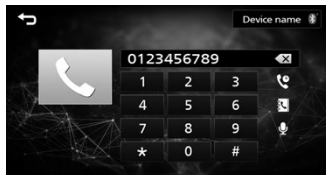



3 Zie de tabel hieronder voor elk van de methodes.



Bellen door een telefoonnummer in te voeren

- 1) Voer een telefoonnummer in met de nummertoeetsen.
 - 2) Raak  aan.
Een telefoongesprek tot stand brengen
- Raak  aan om de laatste invoer te wissen.

Bellen via de gesprekslijsten

- 1) Raak  aan.
- 2) Raak  (inkomende gesprekken),  (uitgaande gesprekken),  (gemiste gesprekken) aan.
- 3) Selecteer het telefoonnummer uit de lijst.
Een telefoongesprek tot stand brengen

Bellen via het telefoonboek

- 1) Raak  aan.
 - 2) Selecteer de naam uit de lijst.
Een telefoongesprek tot stand brengen
- : Bijwerken van het telefoonboek.
Druk op deze knop nadat u iets in het telefoonboek van uw smartphone/mobiele telefoon hebt gewijzigd.

Bluetooth

Bluetooth-audioapparaat afspelen

1 Druk op de <🏠> knop.

2 Raak [BT Audio] aan.

■ Bronbedieningsscherm



1 Informatie over het huidige bestand wordt weergegeven.

2 Speelduur/bestandsnummer
Afspeeltijdbalk : Voor bevestiging van huidige afspelpositie.

3 [⏮] : Selecteert willekeurige afspelstand.
[⏪] : Selecteert repeatstand.
[▶], [⏸] : Speelt of pauzeert.
[⏮], [⏭] : Zoekt de vorige/volgende inhoud.
Aangeraakt houden om snel vooruit of snel achteruit te gaan.
[🔍] : Zoekt bestand. (P.59)

📎 OPMERKING

• Aanduidingen in het display en hun beschikbaarheid kan verschillen afhankelijk van het aangesloten toestel.

■ Selecteren van inhoud in een lijst

1 Raak [🔍] aan.

2 Raak het gewenste onderdeel aan.

Wanneer u een categorie aanraakt, wordt diens inhoud weergegeven.

3 Raak het gewenste onderdeel in het inhoudsoverzicht aan.

Het afspelen begint.

• Raak [🏠] aan om een niveau omhoog te gaan.

📎 OPMERKING

• Het bronbedieningsscherm verschijnt wanneer u [🏠] aanraakt op het hoogste niveau.

Installatie

Vóór de installatie

Neem vóór de installatie van dit toestel de volgende voorzorgsmaatregelen in acht.

▲ WAARSCHUWINGEN

- Als u de ontstekingskabel (rood) en de accukabel (geel) op het chassis van de auto (massa) aansluit, kunt u kortsluiting veroorzaken waardoor brand kan ontstaan. Sluit deze kabels altijd aan op de voedingsbron die door de zekeringkast loopt.
- Verwijder niet de zekering van de ontstekingskabel (rood) en de accukabel (geel). De voeding moet zijn aangesloten op de kabels via de zekering.

▲ LET OP

- Installeer dit toestel in de console van uw auto. Raak het metalen deel van dit toestel tijdens of na het gebruik niet aan. Metalen delen zoals de behuizing worden heet.

📎 OPMERKING



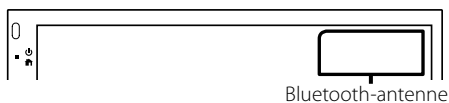

- De montage en aansluiting van dit product vereist kennis en ervaring. Voor uw eigen veiligheid dient u de montage en aansluiting over te laten aan deskundigen.
- Zorg dat het toestel op een negatieve 12 Volt gelijkstroomvoeding is geaard.
- Installeer het toestel niet op plaatsen die aan direct zonlicht, overmatige hitte of vochtigheid blootstaan. Vermijd tevens zeer stoffige plaatsen of plaatsen waar het toestel nat zou kunnen worden.
- Gebruik geen eigen schroeven. Gebruik uitsluitend de bij het toestel geleverde schroeven. Het gebruik van verkeerde schroeven kan het toestel beschadigen.
- Als het contact van uw auto geen ACC-stand heeft, moet u de ontstekingskabel met een spanningsbron verbinden die gelijk met het contact van de auto wordt in- of uitgeschakeld. Als u de ontstekingskabel verbindt met een spanningsbron waar constant spanning op staat, zoals een accukabel, kan de accu leeglopen.
- Als de console een deksel heeft, moet u er bij de installatie van het toestel op letten dat het voorpaneel het deksel bij het openen en sluiten niet raakt.
- Als de zekering is doorgebrand, controleert u eerst of de kabels elkaar niet raken en zo een kortsluiting veroorzaken en vervangt u de zekering door een nieuwe met dezelfde stroomsterkte.
- Isoleer niet-aangesloten kabels met isolatieband of ander geschikt materiaal. Voorkom kortsluiting door de kapjes op het uiteinde van de niet-aangesloten kabels of aansluitingen niet te verwijderen.

Installatie

- Zet de bedrading met behulp van de kabelklemmen en wikkel de vinyltape rond de draden die in contact komt met de metalen delen en om te voorkomen dat de draden om kortsluiting te voorkomen.
- Sluit de luidsprekerkabels correct aan op de corresponderende aansluitingen. Het toestel kan beschadigd raken of niet langer werken als u de ⊖-draden deelt of deze aardt met een metalen onderdeel van het voertuig.
- Indien er maar twee luidsprekers op het systeem worden aangesloten, moeten de connectors óf op de beide voorste uitgangen óf op de beide achterste uitgangen worden aangesloten (verwissel voor en achter niet). Indien u bijvoorbeeld de ⊕ connector van de linker luidspreker op een voorste uitgang aansluit, mag u de ⊖ connector niet op een achterste uitgang aansluiten.
- Controleer na het installeren van het toestel of de remlichten, richtingaanwijzers, ruitenwissers etc. van de auto correct functioneren.
- Installeer het toestel zodanig dat een maximale hoek van 30° wordt bereikt.
- Duw niet te hard op het paneeloppervlak tijdens de installatie van het toestel in het voertuig. Dit kan leiden tot krassen, schade of het niet meer goed functioneren.
- De ontvangst wordt mogelijk slechter wanneer zich metalen voorwerpen in de buurt van de Bluetooth-antenne bevinden.

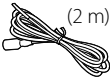

■ Meegeleverde accessoires voor installatie

①		x1	②		x2
③		x1	④		x1
⑤		x1			

■ Installatieprocedure

- 1) Voorkom kortsluiting door de sleutel uit het contactslot te verwijderen en de ⊖ aansluiting van de accu los te koppelen.
- 2) Verbind de juiste in- en uitgangskabels van elk toestel.
- 3) Sluit de connector van de ISO op het toestel aan.
- 4) Installeer het toestel in uw auto.
- 5) Sluit de ⊖-pool van de batterij weer aan.
- 6) Druk op de resetknop.

De unit installeren

■ Niet-Japanse auto's

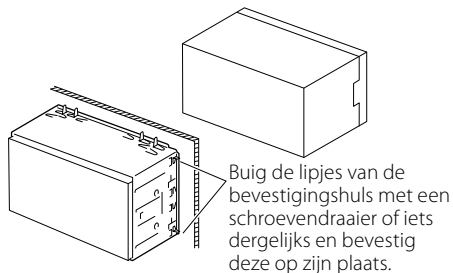

📌 OPMERKING

- Zorg ervoor dat het toestel stevig op zijn plaats zit. Als het toestel instabiel is, kan het slecht functioneren (het geluid kan bijvoorbeeld overslaan).

■ Afwerkingsplaat

- 1) Bevestig de accessoire ① aan het toestel.

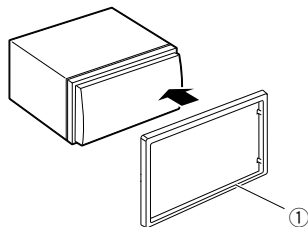

Installatie

De microfoon

- 1) Controleer de installatiepositie van de microfoon (accessoire ④).
- 2) Reinig het installatieoppervlak.
- 3) Verwijder de beschermstrook van de microfoon (accessoire ④) en plak de microfoon op de plek die hieronder wordt getoond.
- 4) Leid de microfoonkabel tot aan de handsfreetkit en zet de kabel op verschillende plaatsen vast met tape of vergelijkbaar materiaal.
- 5) Verstel de microfoon (accessoire ④) in de richting van de bestuurder.

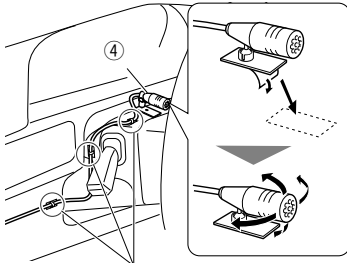

Bevestig de kabel met in de handel verkrijgbare tape.

OPMERKING

- Wissel, zo nodig, de klemmen om.

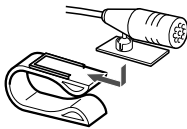

Verwijderen van de afwerkingsplaat

- 1) Gebruik de extractiesleutel (accessoire ③) om de vier lipjes los te wippen (twee aan de linkerkant, twee aan de rechterkant).

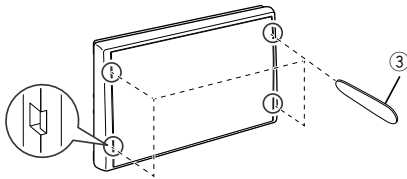

- 2) Trek de afwerkingsplaat naar voren.

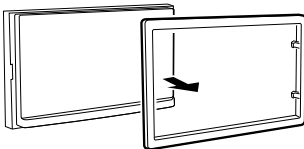

De eenheid verwijderen

- 1) Zie stap 1 in „Verwijderen van de afwerkingsplaat“ voor het verwijderen van het inbouwframe.
- 2) Plaats de extractiesleutel (accessoire ②) diep in de opening, zoals afgebeeld. (Het uitsteksel aan het eind van de extractiesleutel moet naar de eenheid toe wijzen.)

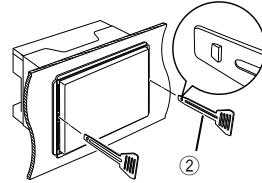

- 3) Wanneer de geplaatste extractiesleutel vastzit, steekt u de andere extractiesleutel in de opening.

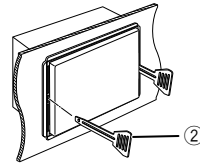

- 4) Trek de eenheid half uit.

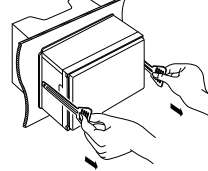

OPMERKING

- Wees voorzichtig om verwonding door de klampennen op de uitbouwseleutel te vermijden.
- 5) Trek het toestel met uw handen geheel naar voren en let op dat u het toestel niet laat vallen.

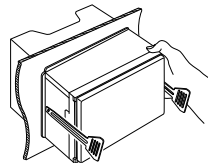

Installatie

■ Verbinden van kabels met aansluitingen

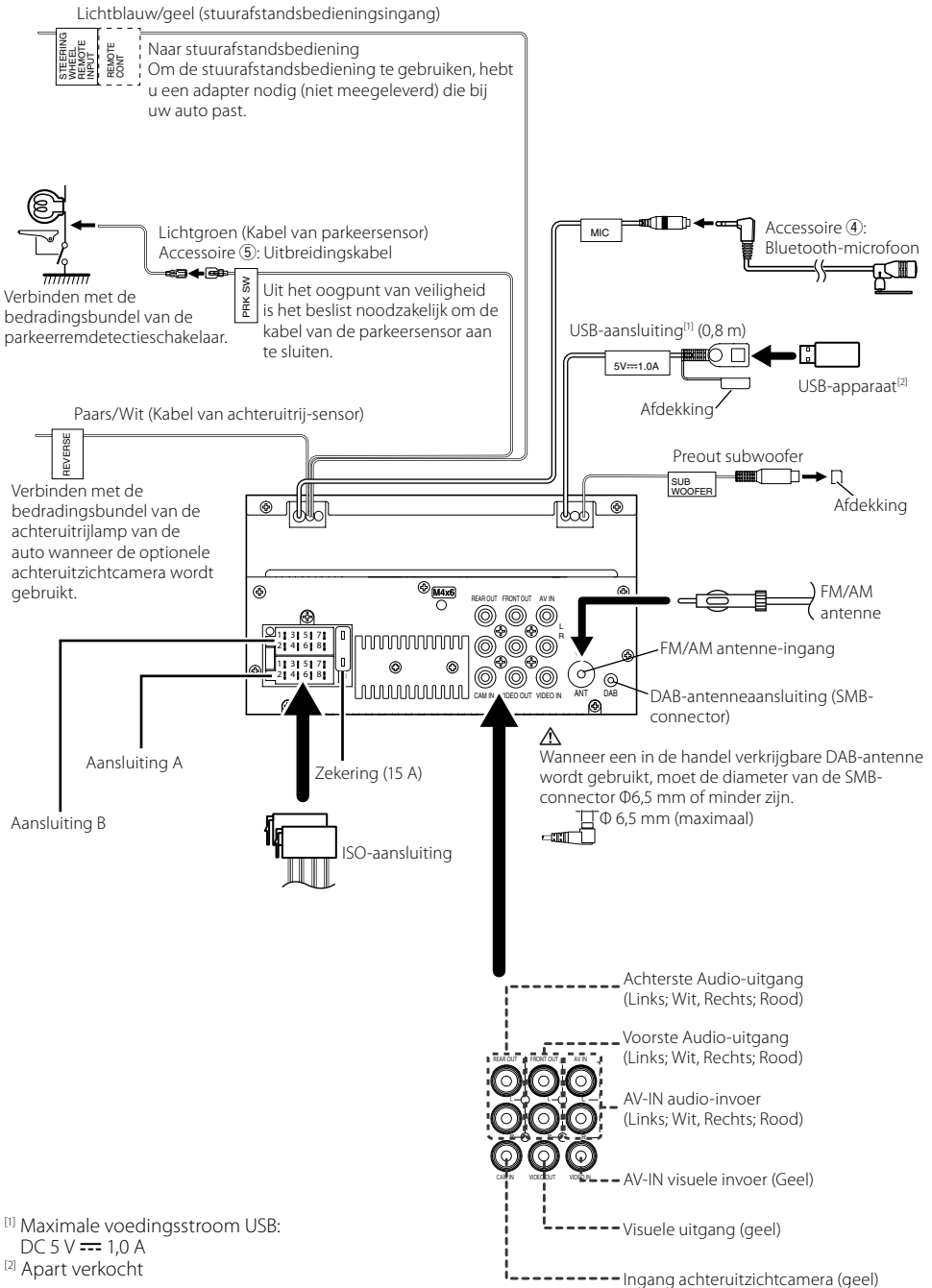

^[1] Maximale voedingsstroom USB:

DC 5 V = 1,0 A

^[2] Apart verkocht

Installatie

■ Kabelboomstekker functieids

Pen	Kleur en functie	
A-4	Geel	Accu
A-5	Blauw/wit ^[1]	Spanningsregeling
A-7	Rood	Ontsteking (ACC)
A-8	Zwart	Aardaansluiting (massa)
B-1/ B-2	Paars (+) / Paars/Zwart (-)	Rechts achter
B-3/ B-4	Grijs (+) / Grijs/Zwart (-)	Rechts voor
B-5/ B-6	Wit (+) / Wit/Zwart (-)	Links voor
B-7/ B-8	Groen (+) / Groen/Zwart (-)	Links achter

^[1] Max. 150 mA, 12 V

- Luidsprekerimpedantie: 4-8 Ω

⚠ VOORZICHTIG

Controleer de volgende toestand, voordat u de vrij verkrijgbare ISO-aansluitingen aansluit aan het apparaat:

- Wees ervan verzekerd dat de pinbezetting van de aansluiting past op het JVC-apparaat.
- Let extra op de stroomkabel.
- In het geval dat de batterijkabel en de ontstekingskabel niet overeenkomen, wissel ze dan.
- In het geval dat de auto geen ontstekingskabel heeft, gebruik dan een vrij verkrijgbare interface.

■ Aansluiten van een iPod/iPhone/Android

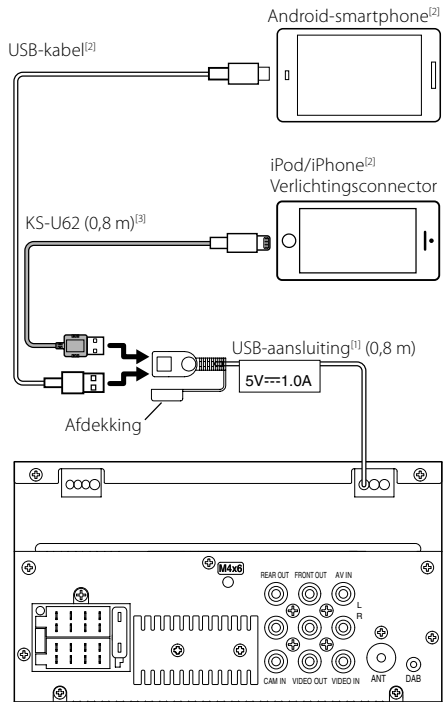

^[1] Maximale voedingsstroom USB:

DC 5 V --- 1,0 A

^[2] Apart verkocht

^[3] Optioneel toebehoren

Informatie over dit toestel

Meer informatie

■ Bruikbaar USB-apparaat

Dit apparaat kan MPEG1/MPEG2/MPEG4/H.264/ MKV/MP3/WMA/AAC/WAV/FLAC en OGC-bestanden die op een USB-geheugen zijn opgeslagen afspelen.

- Bestandssysteem: FAT16/ FAT32

🔧 OPMERKING

- Als het USB-apparaat op dit toestel is aangesloten, kan het via de USB-kabel worden opgeladen.
- Installeer het USB-apparaat op een plaats waar het veilig rijden niet belemmert.
- U kunt een USB-apparaat niet via een USB-hub en multikaartlezer aansluiten.
- Maak back-ups van de audiobestanden die u op dit toestel hebt gebruikt. De bestanden kunnen worden gewist afhankelijk van de bedieningsvoorwaarden van het USB-apparaat.
Wij vergoeden geen schade die op enigerlei wijze door het wissen van gegevens ontstaat.
- Dit toestel is niet met een USB-apparaat uitgerust. U moet zelf een in de handel verkrijgbaar USB-apparaat aanschaffen.
- Plaats de dop op het USB-aansluitpunt wanneer u deze niet gebruikt.

■ Afspeelbare audiobestanden

Audioformaat	Verlenging
MP3	.mp3
WMA	.wma
AAC-LC	.m4a, .aac
Lineaire PCM (WAVE)	.wav
FLAC	.flac
Vorbis	.ogg

- Dit apparaat kan ID3 Label Versie 1.0/1.1/2.2/2.3/2.4 (voor MP3) tonen.

🔧 OPMERKING

- WMA en AAC kunnen niet worden afgespeeld indien gedekt door DRM.
- Hoewel de audiobestanden voldoen aan de hierboven vermelde standaarden, is het mogelijk dat ze niet kunnen worden afgespeeld. Dit is afhankelijk van het type media of apparaat en de omstandigheden waaronder de media of het apparaat wordt gebruikt.

■ Aanvaardbare videobestanden

Videoformaat	Verlenging
MPEG-1	.mpg, .mpeg
MPEG-2	.mpg, .mpeg
MPEG-4	.mp4, .avi

H.264/MPEG-4 AVC	.mp4, mkv, avi, .flv, .f4v, .ts
MKV	.mkv

Opmerking voor specificaties

■ Bluetooth-gedeelte

Frequentie

: 2,402 – 2,480 GHz

Uitgangsvermogen

: +8 dBm (AVE), Power Class1

■ Algemeen

Luidsprekerimpedantie

: 4 – 8 Ω

Bedrijfsspanning

: 12 V gelijkstroom autoaccu

Auteursrechten

- Het Bluetooth®-woordmerk logo's zijn geregistreerde handelsmerken die eigendom zijn van Bluetooth SIG, Inc. en het gebruik van dergelijke handelsmerken door JVCKENWOOD Corporation is onder licentie. Andere handelsmerken en handelsnamen zijn het eigendom van hun respectievelijke houders.
- Use of the Made for Apple badge means that an accessory has been designed to connect specifically to the Apple product(s) identified in the badge and has been certified by the developer to meet Apple performance standards. Apple is not responsible for the operation of this device or its compliance with safety and regulatory standards. Please note that the use of this accessory with an Apple product may affect wireless performance.
- Apple, iPhone, iPod, iPod touch, and Lightning are trademarks of Apple Inc., registered in the U.S. and other countries.
- Microsoft and Windows Media are either registered trademarks or trademarks of Microsoft Corporation in the United States and/or other countries.
- THIS PRODUCT IS LICENSED UNDER THE MPEG-4 VISUAL PATENT PORTFOLIO LICENSE FOR THE PERSONAL AND NON-COMMERCIAL USE OF A CONSUMER FOR (i) ENCODING VIDEO IN COMPLIANCE WITH THE MPEG-4 VISUAL STANDARD ("MPEG-4 VIDEO") AND/OR (ii) DECODING MPEG-4 VIDEO THAT WAS ENCODED BY A CONSUMER ENGAGED IN A PERSONAL AND NON-COMMERCIAL ACTIVITY AND/OR WAS OBTAINED FROM A VIDEO PROVIDER LICENSED BY MPEG LA TO PROVIDE MPEG-4 VIDEO. NO LICENSE IS GRANTED OR SHALL BE IMPLIED FOR ANY OTHER USE. ADDITIONAL INFORMATION INCLUDING THAT RELATING TO PROMOTIONAL, INTERNAL AND COMMERCIAL USES AND LICENSING MAY BE OBTAINED FROM MPEG LA, LLC. SEE [HTTP://WWW.MPEGLA.COM](http://www.mpegla.com).

Informatie over dit toestel

- THIS PRODUCT IS LICENSED UNDER THE AVC PATENT PORTFOLIO LICENSE FOR THE PERSONAL USE OF A CONSUMER OR OTHER USES IN WHICH IT DOES NOT RECEIVE REMUNERATION TO ((j)ENCODE VIDEO IN COMPLIANCE WITH THE AVC STANDARD ("AVC VIDEO") AND/OR ((j)DECODE AVC VIDEO THAT WAS ENCODED BY A CONSUMER ENGAGED IN A PERSONAL ACTIVITY AND/OR WAS OBTAINED FROM A VIDEO PROVIDER LICENSED TO PROVIDE AVC VIDEO. NO LICENSE IS GRANTED OR SHALL BE IMPLIED FOR ANY OTHER USE. ADDITIONAL INFORMATION MAY BE OBTAINED FROM MPEG LA, L.L.C. SEE [HTTP://WWW.MPEGLA.COM](http://www.mpegla.com)

• libFLAC

Copyright (C) 2000-2009 Josh Coalson

Copyright (C) 2011-2013 Xiph.Org Foundation

– Redistribution and use in source and binary forms, with or without modification, are permitted provided that the following conditions are met:

– Redistributions of source code must retain the above copyright notice, this list of conditions and the following disclaimer.

– Redistributions in binary form must reproduce the above copyright notice, this list of conditions and the following disclaimer in the documentation and/or other materials provided with the distribution.

Neither the name of the Xiph.org Foundation nor the names of its contributors may be used to endorse or promote products derived from this software without specific prior written permission.

THIS SOFTWARE IS PROVIDED BY THE COPYRIGHT HOLDERS AND CONTRIBUTORS "AS IS" AND ANY EXPRESS OR IMPLIED WARRANTIES, INCLUDING, BUT NOT LIMITED TO, THE IMPLIED WARRANTIES OF MERCHANTABILITY AND FITNESS FOR A PARTICULAR PURPOSE ARE DISCLAIMED. IN NO EVENT SHALL THE FOUNDATION OR CONTRIBUTORS BE LIABLE FOR ANY DIRECT, INDIRECT, INCIDENTAL, SPECIAL, EXEMPLARY, OR CONSEQUENTIAL DAMAGES (INCLUDING, BUT NOT LIMITED TO, PROCUREMENT OF SUBSTITUTE GOODS OR SERVICES; LOSS OF USE, DATA, OR PROFITS; OR BUSINESS INTERRUPTION) HOWEVER CAUSED AND ON ANY THEORY OF LIABILITY, WHETHER IN CONTRACT, STRICT LIABILITY, OR TORT (INCLUDING NEGLIGENCE OR OTHERWISE) ARISING IN ANY WAY OUT OF THE USE OF THIS SOFTWARE, EVEN IF ADVISED OF THE POSSIBILITY OF SUCH DAMAGE.

• libogg

Copyright (c) 2002, Xiph.org Foundation Redistribution and use in source and binary forms, with or without modification, are permitted provided that the following conditions are met:

– Redistributions of source code must retain the above copyright notice, this list of conditions and the following disclaimer.

– Redistributions in binary form must reproduce the above copyright notice, this list of conditions and the following disclaimer in the documentation and/or other materials provided with the distribution.

– Neither the name of the Xiph.org Foundation nor the names of its contributors may be used to endorse or promote products derived from this software without specific prior written permission.

THIS SOFTWARE IS PROVIDED BY THE COPYRIGHT HOLDERS AND CONTRIBUTORS "AS IS" AND ANY EXPRESS OR IMPLIED WARRANTIES, INCLUDING, BUT NOT LIMITED TO, THE IMPLIED WARRANTIES OF MERCHANTABILITY AND FITNESS FOR A PARTICULAR PURPOSE ARE DISCLAIMED. IN NO EVENT SHALL THE FOUNDATION OR CONTRIBUTORS BE LIABLE FOR ANY DIRECT, INDIRECT, INCIDENTAL, SPECIAL, EXEMPLARY, OR CONSEQUENTIAL DAMAGES (INCLUDING, BUT NOT LIMITED TO, PROCUREMENT OF SUBSTITUTE GOODS OR SERVICES; LOSS OF USE, DATA, OR PROFITS; OR BUSINESS INTERRUPTION) HOWEVER CAUSED AND ON ANY THEORY OF LIABILITY, WHETHER IN CONTRACT, STRICT LIABILITY, OR TORT (INCLUDING NEGLIGENCE OR OTHERWISE) ARISING IN ANY WAY OUT OF THE USE OF THIS SOFTWARE, EVEN IF ADVISED OF THE POSSIBILITY OF SUCH DAMAGE.

■ Informatie over het verwijderen van oude elektrische en elektronische apparatuur en batterijen (van toepassing op Europese landen waar afval wordt gescheiden)

Dit symbool geeft aan dat gebruikte elektrische, elektronische producten en batterijen niet bij het normale huishoudelijke afval mogen.

Oude elektrische en elektronische apparaten en batterijen moeten worden gerecycled door een hiervoor geschikte faciliteit.

Raadpleeg de lokale betreffende instantie voor details aangaande een geschikte recycle-faciliteit in uw buurt.

Het juist recyclen en weggooien van vuil helpt bronnen te besparen en vermindert een schadelijke invloed op uw gezondheid en het milieu.

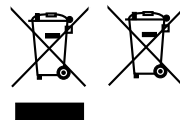

Indice

Prima dell'uso.....	66
Come utilizzare questo manuale.....	66
Precauzioni.....	66
Per iniziare.....	67
Impostazioni orologio.....	67
Di base.....	68
Funzioni dei pulsanti sul pannello frontale.....	68
Operazioni comuni.....	68
Schermata HOME.....	68
Schermata di controllo della sorgente.....	68
Radio digitale.....	69
Funzionamento di base della radio digitale.....	69
Configurazione Radio digitale.....	69
Sintonizzatore.....	70
Funzionamento di base sintonizzatore.....	70
Configurazione sintonizzatore.....	70
USB.....	71
Preparazione.....	71
Operazioni di riproduzione.....	71
iPod/iPhone.....	72
Preparazione.....	72
Operazioni di riproduzione.....	72
Componenti esterni.....	73
Utilizzo di lettori audio/video esterni.....	73
Telecamera a retrovisione.....	73
Regolazione audio.....	73
Regolazione generale dell'audio.....	73
Bluetooth.....	74
Registrare il proprio smartphone sull'unità.....	74
Ricevere una telefonata.....	74
Effettuare una telefonata.....	74
Riproduzione del dispositivo audio Bluetooth.....	75
Installazione.....	75
Prima dell'installazione.....	75
Installazione dell'unità.....	76
Informazioni su questa unità.....	80
Ulteriori informazioni.....	80
Nota per le specifiche.....	80
Copyright.....	80

- Per le operazioni e le informazioni dettagliate, fare riferimento al MANUALE DI ISTRUZIONI disponibile sul seguente sito web:



<<https://www.jvc.net/cs/car/>>

Come utilizzare questo manuale

- Le immagini dei pannelli riportate in questa guida sono esempi utilizzati per spiegare in modo chiaro il funzionamento. Per questo motivo, possono differire dagli effettivi pannelli.
- Nelle procedure operative, il tipo di parentesi indica il tasto o il pulsante da azionare.
 - < >: Indica il nome dei pulsanti del pannello.
 - []: Indica i nomi dei tasti a sfioramento.

Prima dell'uso

Precauzioni

▲ AVVERTENZA

■ Per prevenire lesioni o incendi, adottare le seguenti precauzioni:

- Per prevenire cortocircuiti, non mettere né lasciare mai oggetti metallici (quali monete o attrezzi di metallo) all'interno dell'unità.
- Non fissare a lungo il display dell'unità durante la guida.
- Se si verificano problemi durante l'installazione, consultare il rivenditore JVC.

■ Precauzioni per l'uso di questa unità

- Quando si acquistano accessori opzionali, verificare con il rivenditore JVC che siano compatibili con il proprio modello e che siano utilizzabili nel proprio Paese.
- Le funzioni Radio Data System o Radio Broadcast Data System non funzionano se tale servizio non è fornito dalle emittenti.

■ Protezione del monitor

- Per evitare che il monitor si danneggi, non toccarlo con una penna a sfera o oggetti simili appuntiti.

■ Pulizia dell'unità

Se il frontalino di questa unità è macchiato, pulirlo con un panno morbido asciutto come ad esempio un panno al silicone. Se il frontalino è molto macchiato, rimuovere la macchia con un panno imbevuto di un detergente neutro, quindi ripulirlo con un panno morbido pulito e asciutto.

▲ ATTENZIONE

- Applicare detergenti spray direttamente sull'unità può danneggiare i componenti meccanici. Pulendo il frontalino con un panno non morbido o usando un liquido volatile come diluente o alcol si rischia di graffiare la superficie o di cancellare le serigrafie.

■ Reset dell'unità

Se l'unità o l'unità collegata non funziona correttamente, eseguirne il ripristino.

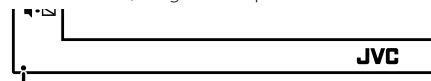

Pulsante di ripristino



Questo simbolo visibile sull'apparecchio indica che nel manuale sono presenti istruzioni importanti sull'uso e la manutenzione. Assicurarsi di leggere attentamente le istruzioni in questo manuale.

Per iniziare

1 Ruotare la chiave di accensione dell'automobile in posizione ACC.

L'unità si accende.

2 Premere il pulsante <🏠>.

3 Sfiurare [⚙️].

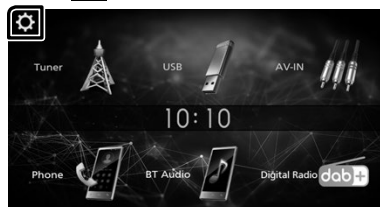

4 Sfiurare il tasto corrispondente e impostare il valore.



[System]

[Beep Tone]

Attiva o disattiva il tono tastiera.
"ON" (ACCESO) (Predefinito), "OFF" (SPENTO)

[Language]

Seleziona la lingua utilizzata per la schermata di controllo e le voci di impostazione. La lingua predefinita è "English" (Inglese).

[Time/Date]

Regolare l'orologio. (P.67)

[Clock Mode]

Selezionare il formato di visualizzazione dell'ora.
[12hr]/[24hr] (Predefinito)

[Parking Guidelines]

È possibile visualizzare le linee guida per il parcheggio per facilitare il parcheggio quando si innesta la retromarcia (R). L'impostazione predefinita è "ON".

[Guidelines SETUP]

Se si seleziona [ON] per [Parking Guidelines], è possibile regolare le linee guida per il parcheggio.

[System Reset]

Toccare [System Reset] e quindi toccare [YES] per riportare tutte le impostazioni alle impostazioni iniziali predefinite.

[Bluetooth]

Viene visualizzata la schermata Impostazioni Bluetooth.

[Screen]

[Dimmer]

Selezionare la modalità di attenuazione.
"High" (predefinito)/"Mid"/"Low"

[Demo]

Selezionare la modalità dimostrazione.
L'impostazione predefinita è "ON".

[Information]

Visualizza la versione del software di questa unità.

5 Sfiurare [↔️].

Impostazioni orologio

☑️ Sincronizzazione dell'orologio con FM RDS

Attivare [RDS Clock Sync] (Sinc. orologio RDS).
Vedere **Configurazione sintonizzatore (P.70)**.

☑️ Regolazione manuale dell'orologio

🔑 NOTA

- Disattivare [RDS Clock Sync] prima di regolare l'orologio.

1 Premere il pulsante <🏠>.

2 Sfiurare [⚙️].

3 Sfiurare [System].

4 Sfiurare [Time/Date].

Compare la schermata Orologio.

5 Toccare [▲] o [▼] per impostare l'orologio.

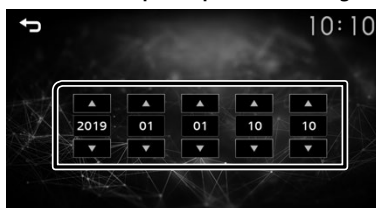

6 Sfiurare [↔️].

Di base

Funzioni dei pulsanti sul pannello frontale

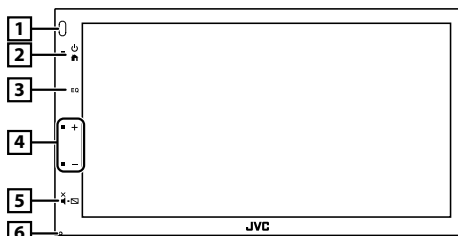

- 1 Sensore remoto**
 - Riceve il segnale del telecomando.
- 2  (HOME)**
 - Visualizza la versione del software di questa unità. **(P.68)**
 - Premendolo per 1 secondo disinscrive l'alimentazione.
 - Se l'alimentazione è disinserita, la inserisce.
- 3 EQ**
 - Visualizza la schermata Audio.* **(P.73)**
 - * La schermata Audio non è visualizzata durante la schermata di CONFIGURAZIONE o nella schermata dell'elenco, ecc.
- 4 +, - (Volume)**
 - Regola il volume. Il volume aumenta fino a 20 quando si tiene premuto [+].
- 5  (MUTO, Display off)**
 - Tacita/ripristina il suono.
 - Premendo per 1 secondo si spegne lo schermo. Quando lo schermo è spento, toccare il display per accenderlo.
- 6 Ripristino**
 - Se l'unità o l'unità collegata non funzionano correttamente, premendo questo pulsante l'unità ritorna alle impostazioni predefinite.

Operazioni comuni

Accensione

- 1 Premere il pulsante .



Spegnimento

- 1 Tenere premuto il pulsante .

Schermata HOME

- 1 Premere il pulsante .



Compare la schermata HOME.



- 1 Display orologio
- 2 Passa alla trasmissione radio. **(P.70)**
- 3 **[USB]** 
Riproduce i file su un dispositivo USB. **(P.71)**
[iPod] 
Riproduce un iPod/iPhone. **(P.72)**
 - Quando un iPod/iPhone è connesso.**[Mirroring]** 
Visualizza la schermata Mirroring.
 - Quando è collegato un dispositivo Android con l'applicazione "Mirroring OB for JVC" installata.
- 4 Passa a un componente esterno connesso al terminale di ingresso AV-IN. **(P.73)**
- 5 Visualizza la schermata Vivavoce. **(P.74)**
- 6 Riproduce un lettore audio Bluetooth. **(P.75)**
- 7 Passa alla trasmissione radio digitale. **(P.69)**
- 8 Viene visualizzata la schermata IMPOSTAZIONE. **(P.67)**

Schermata di controllo della sorgente



- 1 : Ritorna alla schermata precedente.
: Visualizza la schermata Audio. **(P.73)**

Radio digitale

Funzionamento di base della radio digitale

1 Premere il pulsante .

2 Sfiore [Digital Radio].

■ Schermata di controllo della sorgente

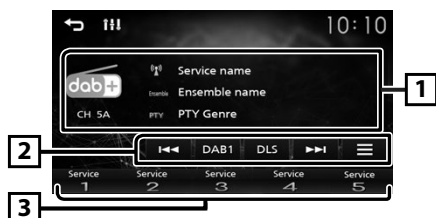

1 Vengono visualizzate le informazioni sul servizio corrente:

nome del servizio, nome gruppo, genere PTY, canale

2 **[DAB]**: Commuta la banda di preselezione della radio digitale.

“DAB1”, “DAB2”, “DAB3”

[DLS]: Visualizzare la schermata Segmento etichetta dinamica

[◀▶]: Selezionare un gruppo, un servizio e un componente.

[☰]: Visualizza la schermata Configurazione radio digitale (P.69)

3 Richiama l'etichetta servizio memorizzata.

Se toccato per 2 secondi, archivia il servizio attualmente in ricezione nella memoria.

■ Memorizzare un servizio

È possibile memorizzare il servizio di ricezione corrente nella memoria.

1 Sintonizzarsi su un servizio che si desidera preimpostare.

2 Toccare e tenere premuto [#] (#:1-5) nel quale si desidera memorizzare il servizio.

■ Selezionare un servizio memorizzato

1 Sfiore [#] (#:1-5).

Configurazione Radio digitale

1 Sfiore .

2 Impostare ogni voce come segue.

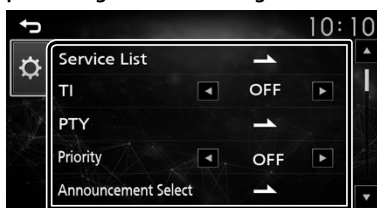

[Service List]

Visualizza la schermata dell'elenco servizi.

- : Toccare, quindi toccare [Yes] per trovare l'elenco più recente dei servizi.

[TI]

Passa automaticamente alle informazioni sul traffico quando inizia la trasmissione di un bollettino sul traffico.

“ON”, “OFF” (predefinito)

[PTY]

Ricerca un programma in base al tipo di programma.

[Priority]

Se lo stesso servizio viene fornito anche dalla rete Radio Data System, qualora la ricezione della radio digitale dovesse affievolirsi, questo automaticamente commuta alla funzione Radio Data System.

“ON”, “OFF” (predefinito)

[Announcement Select]

Seleziona il servizio di annunci prescelto.

[Related Service]

Quando si seleziona ON, l'unità passa a un'etichetta servizio correlata (se presente) quando una rete etichetta servizio DAB non è disponibile. L'impostazione predefinita è “OFF”.

[Antenna Power]

Imposta l'alimentazione di corrente all'antenna della radio digitale. Impostare su “ON” quando l'antenna della radio digitale in uso è dotata di un amplificatore. L'impostazione predefinita è “ON”.

3 Sfiore .

Sintonizzatore

Funzionamento di base sintonizzatore

- 1 Premere il pulsante .
- 2 Sfiore [Tuner].

Schermata di controllo della sorgente

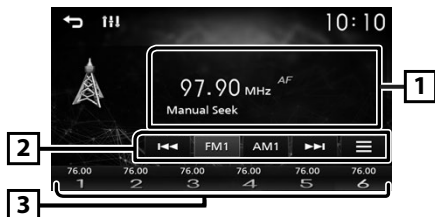

- 1 Visualizza le informazioni della stazione attuale: Nome PS, Frequenza, Genere PTY, Voci di indicazione

- 2 **[FM]** : Cambia la banda FM.
"FM1", "FM2", "FM3"

[AM] : Cambia la banda AM.
"AM1", "AM2"

[◀▶] : Consente di sintonizzare automaticamente una stazione con una buona ricezione.

[☰] : Visualizza la schermata CONFIGURAZIONE sintonizzatore. **(P.70)**

- 3 Richiama la stazione memorizzata.
Se toccato per 2 secondi, memorizza la stazione attualmente in ricezione nella memoria.

Memorizzazione automatica

È possibile preimpostare 6 stazioni per la banda corrente (FM1/FM2/FM3/AM1/AM2).

- 1 Toccare **[FM]** o **[AM]** per selezionare la banda.
- 2 Sfiore **[☰]**.
- 3 Sfiore **[Auto Store]**.

Le stazioni locali con i segnali più forti vengono individuate e memorizzate automaticamente.

Memorizzazione manuale

È possibile memorizzare la stazione di ricezione corrente nella memoria.

- 1 Sintonizzarsi su una stazione che si desidera preimpostare.
- 2 Sfiore e tenere premuto **[#]** (#:1-6) nel quale si desidera memorizzare la stazione.

Richiamo delle stazioni memorizzate

- 1 Sfiore **[#]** (#:1-6).

Configurazione sintonizzatore

- 1 Sfiore **[☰]**.
- 2 Impostare ogni voce come segue.

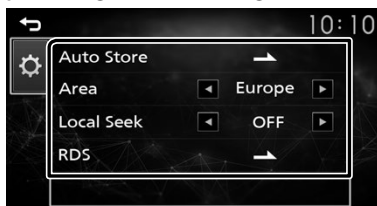

[Auto Store]

Cerca automaticamente e memorizza le 6 stazioni con il segnale più forte per la banda selezionata.

Appare "Auto Store" (memorizzazione automatica).

[Local Seek]

Si sintonizza solo sulle stazioni con segnale sufficientemente forte. (L'indicatore **LOC** si accende).

"ON", "OFF" (predefinito)

[RDS] *1

Viene visualizzata la schermata Impostazioni RDS.

[AF]

Quando il segnale trasmesso dalla stazione è debole, passa automaticamente alla stazione che trasmette lo stesso programma sulla stessa rete Radio Data System.

"ON" (ACCESO) (Predefinito), "OFF" (SPENTO)

[TA]

Passa automaticamente alle informazioni sul traffico quando inizia la trasmissione di un bollettino sul traffico. (L'indicatore **TI** si accende.)
"ON", "OFF" (predefinito)

[RDS Clock Sync]

Sincronizzazione dei dati orario stazione Sistema dati radio e dell'orologio di questa unità.

"ON" (ACCESO) (Predefinito), "OFF" (SPENTO)

[PTY]

Selezionare un tipo di programma.

[PTY Seek]

Ricerca un programma in base al tipo di programma.

*1 Solo FM

- 3 Sfiore **[↩]**.

USB

Preparazione

■ Connessione di un dispositivo USB

- 1 Togliere il cappuccio al terminale USB.
- 2 Collegare il dispositivo USB con l'apposito cavo.

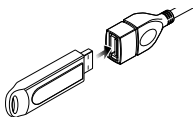

L'unità legge il dispositivo e inizia la riproduzione.

■ Per scollegare il dispositivo USB:

- 1 Premere il pulsante <🏠>.
- 2 Toccare una sorgente diversa da [USB].
- 3 Scollegare il dispositivo USB.

■ Dispositivi USB utilizzabili

Questa unità può riprodurre file MPEG1/MPEG2/MPEG4/H.264/MKV/MP3/WMA/AAC/WAV/FLAC/OGG memorizzati in un dispositivo di archiviazione di massa USB.

Operazioni di riproduzione

■ Controllare la musica che si sta ascoltando dalla schermata di controllo della sorgente.



- 1 Viene visualizzata la copertina del file attualmente in riproduzione.
- 2 Vengono visualizzate le informazioni sul file corrente.
- 3 Tempo di riproduzione/Numero file
Barra del tempo di riproduzione: Per confermare la posizione di riproduzione corrente.
- 4 [▶] : Seleziona la modalità Riproduzione casuale.
[🔁] : Seleziona la modalità Riproduzione ripetuta.
[⏸], [⏹] : Riproduce o mette in pausa.

[⏮], [⏭] : Ricerca il contenuto precedente/successivo.

Sfiorare e mantenere il contatto per avanzare/tornare indietro velocemente.

[🔍] : Ricerca il file. (P.71)

■ Per la riproduzione video

1 Quando i pulsanti funzione non sono visualizzati sullo schermo, toccare il display.

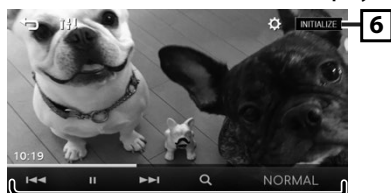

6 [⚙] : è possibile regolare la qualità dell'immagine nella schermata video.

[INITIALIZE] : per cancellare la regolazione.

7 [▶], [⏹] : Riproduce o mette in pausa.

[⏮], [⏭] : Ricerca il contenuto precedente/successivo.

Sfiorare e mantenere il contatto per avanzare/tornare indietro velocemente.

[🔍] : Ricerca il file. (P.71)

[NORMAL]/[16:9]/[4:3] : Selezionare una modalità dello schermo.

■ Selezione di un brano da un elenco (ricerca i file)

- 1 Sfiorare [🔍].
- 2 Selezionare se ricercare per file audio [🎵] o per file video [🎬].
- 3 Toccare [🏠] per spostarsi al livello gerarchico superiore.
- 4 Sfiorare la cartella desiderata.
Quando si sfiora una cartella, viene visualizzato il relativo contenuto.
• Toccare [🏠] per spostarsi al livello gerarchico superiore.
- 5 Sfiorare la voce desiderata dall'elenco dei contenuti.
Inizia la riproduzione.

📌 NOTA

- Viene visualizzata la schermata di controllo della sorgente quando si tocca [🏠] al livello gerarchico superiore.

iPod/iPhone

Preparazione

■ Connessione di un iPod/iPhone

- Per i modelli con connettore luminoso: Utilizzare un cavo audio USB per iPod/iPhone—KS-U62 (accessorio opzionale).
- Per i dettagli sulla connessione di iPod/iPhone, vedere a pagina 79.

1 Togliere il cappuccio al terminale USB.

2 Collegare l'iPod/iPhone.

L'unità legge il dispositivo e inizia la riproduzione.

■ Per disconnettere l'iPod/iPhone

1 Premere il pulsante <🏠>.

2 Toccare una sorgente diversa da [iPod].

3 Scollegare l'iPod/iPhone.

■ iPod/iPhone collegabili

A quest'unità è possibile collegare i seguenti modelli.

Per

- | | | |
|------------------------------|---------------------|------------------|
| • iPhone 12 Pro Max | • iPhone 11 Pro Max | • iPhone 8 Plus |
| • iPhone 12 Pro | • iPhone 11 Pro | • iPhone 8 |
| • iPhone 12 | • iPhone 11 | • iPhone 7 Plus |
| • iPhone 12 mini | • iPhone XS Max | • iPhone 7 |
| • iPhone SE (2nd generation) | • iPhone XS | • iPhone SE |
| | • iPhone XR | • iPhone 6s Plus |
| | • iPhone X | • iPhone 6 Plus |

📎 NOTA

- Se si avvia la riproduzione dopo aver collegato l'iPod, viene riprodotta prima la musica che è stata riprodotta dall'iPod.
- Mettere sempre il cappuccio al terminale USB quando non è in uso.

Operazioni di riproduzione

■ Controllare la musica che si sta ascoltando dalla schermata di controllo della sorgente.



1 Copertina (mostrata se il brano contiene una copertina)

2 Vengono visualizzate le informazioni sul file corrente.

3 Tempo di riproduzione/Numero file
Barra del tempo di riproduzione : Per confermare la posizione di riproduzione corrente.

4 [⏮] : Seleziona la modalità Riproduzione casuale.

[🔄] : Seleziona la modalità Riproduzione ripetuta.

[▶], [⏸] : Riproduce o mette in pausa.

[⏪], [⏩] : Ricerca il contenuto precedente/successivo.
Sfiorare e mantenere il contatto per avanzare/tornare indietro velocemente.

[🔍] : Ricerca i contenuti. (P.72)

■ Selezione di un contenuto in un elenco

1 Sfiore [Q].

2 Sfiore la voce desiderata.

Quando si tocca una categoria, viene visualizzato il relativo contenuto.

3 Sfiore la voce desiderata dall'elenco dei contenuti.

Inizia la riproduzione.

- Toccare [🏠] per spostarsi al livello gerarchico superiore.

📎 NOTA

- Viene visualizzata la schermata di controllo della sorgente quando si tocca [🏠] al livello gerarchico superiore.

Componenti esterni

Utilizzo di lettori audio/video esterni

Inizio della riproduzione

- 1 Connettere un componente esterno al terminale di ingresso AV-IN. (P.78)
- 2 Premere il pulsante <Home>.
- 3 Sforare [AV-IN].
- 4 Accendere il componente connesso e avviare la riproduzione della sorgente.

Per la riproduzione video

- 1 Quando i pulsanti funzione non sono visualizzati sullo schermo, toccare il display.

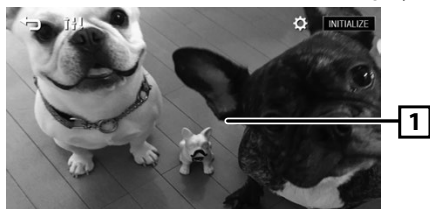

Telecamera a retrovisione

Per utilizzare una telecamera a retrovisione, è necessaria una connessione del cavo REVERSE. Per collegare una telecamera a retrovisione. (P.78)

Visualizzazione dell'immagine dalla telecamera a retrovisione

La schermata a retrovisione viene visualizzata quando si innesta la retromarcia (R).



- Per cancellare il messaggio di attenzione, toccare lo schermo.

Regolazione audio

È possibile regolare varie impostazioni, per esempio il bilanciamento audio o il livello del subwoofer.

- 1 Premere il pulsante <EQ>.
- 2 Per ciascun metodo di funzionamento, fare riferimento a quanto segue.

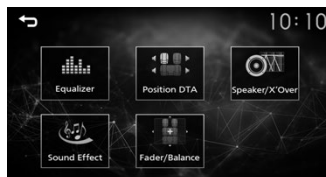

Regolazione generale dell'audio

- 1 Premere il pulsante <EQ>.
- 2 Sforare [Fader / Balance].
- 3 Impostare ogni voce come segue.



[Fader Balance]

Balance Regolare il bilanciamento del volume sinistro e destro.

[▶] [◀]
Da 15 (destra) a 15 (sinistra)

Fader Regolare il bilanciamento del volume anteriore e posteriore.

[▲] [▼]
Da 15 (anteriore) a 15 (posteriore)

[INITIALIZE] Per cancellare la regolazione.

Bluetooth

Registrare il proprio smartphone sull'unità.

È possibile utilizzare il proprio smartphone Bluetooth se è abbinato a quest'unità.

1 Attivare la funzione Bluetooth sul proprio smartphone/telefono cellulare.

2 Ricercare l'unità ("KW-M27DBT") dal proprio smartphone o cellulare.

Se viene richiesto un codice PIN, immettere il codice PIN ("0000").

-  compare quando è connesso lo smartphone dotato di Bluetooth.

Disconnessione del dispositivo

- Disattivare la funzione Bluetooth sul proprio smartphone/telefono cellulare.
- Spegnere l'interruttore di accensione.

Ricevere una telefonata

1 Sfiore [📞].

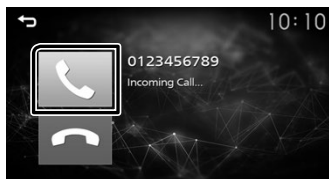

- : Rifutare una chiamata in arrivo.

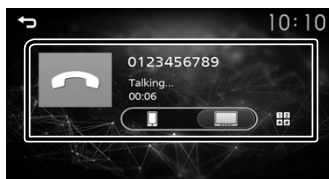

Operazioni durante una chiamata



 Terminare una chiamata

 È possibile inviare i toni sfiorando i tasti desiderati sulla schermata.

- Toccare  per chiudere la finestra.

  Commuta l'uscita della voce del parlato tra lo smartphone/telefono cellulare e l'altoparlante.

- **Regolare il volume del ricevitore**
Premere il pulsante < + > o < - >.

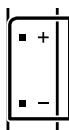

Effettuare una telefonata



1 Premere il pulsante < 🏠 >.

2 Sfiore [Phone].

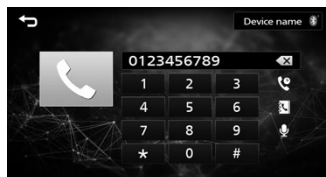



3 Per ciascuna funzione, fare riferimento alla seguente tabella.





Chiamata tramite inserimento di un numero di telefono

- 1) Inserire un numero telefonico utilizzando i tasti numerici.
- 2) Sfiore .
Effettuare una chiamata
- Toccare  per eliminare l'ultimo inserimento.

Chiamata utilizzando l'elenco delle chiamate

- 1) Sfiore .
- 2) Toccare  (Chiamate in entrata),  (Chiamate in uscita),  (Chiamate perse).
- 3) Selezionare il numero telefonico dall'elenco.
Effettuare una chiamata

Chiamata mediante rubrica telefonica

- 1) Sfiore .
- 2) Selezionare il nome dall'elenco.
Effettuare una chiamata
- : Consente di aggiornare la rubrica. Toccare questo pulsante dopo aver eseguito una modifica nella rubrica dello smartphone/telefono cellulare.

Riproduzione del dispositivo audio Bluetooth

1 Premere il pulsante <🏠>.

2 Sfiore [BT Audio].

📄 Schermata di controllo della sorgente



1 Vengono visualizzate le informazioni sul file corrente.

2 Tempo di riproduzione/Numero file
Barra del tempo di riproduzione: Per confermare la posizione di riproduzione corrente.

3 [🔍]: Seleziona la modalità Riproduzione casuale.

[🔁]: Seleziona la modalità Riproduzione ripetuta.

[▶], [⏸]: Riproduce o mette in pausa.

[⏮], [⏭]: Ricerca il contenuto precedente/successivo.

Sfiore e mantenere il contatto per avanzare/tornare indietro velocemente.

[🔍]: Ricerca il file. (P.75)

🔧 NOTA

- Le operazioni e le indicazioni del display possono variare in base alla disponibilità sul dispositivo collegato.

📄 Selezione di un contenuto in un elenco

1 Sfiore [🔍].

2 Sfiore la voce desiderata.

Quando si tocca una categoria, viene visualizzato il relativo contenuto.

3 Sfiore la voce desiderata dall'elenco dei contenuti.

Inizia la riproduzione.

- Toccare [↩] per spostarsi al livello gerarchico superiore.

🔧 NOTA

- Viene visualizzata la schermata di controllo della sorgente quando si tocca [↩] al livello gerarchico superiore.

Installazione

Prima dell'installazione

Prima dell'installazione di quest'unità, osservare le seguenti precauzioni.

⚠️ AVVERTENZE

- Se si collega il cavo di accensione (rosso) e il cavo della batteria (giallo) al telaio della vettura (massa), si potrebbe provocare un cortocircuito, dal quale potrebbe scaturire un incendio. Collegare sempre questi cavi all'alimentazione passante per la scatola fusibili.
- Non escludere il fusibile dal cavo di accensione (rosso) e dal cavo della batteria (giallo). L'alimentazione deve essere collegata ai cavi tramite il fusibile.

⚠️ ATTENZIONE

- Installare quest'unità nella console del veicolo. Durante e immediatamente dopo l'uso dell'unità non toccare la parte metallica dell'unità stessa, poiché la temperatura delle parti metalliche, come ad esempio il termodispersore e il contenitore, può diventare molto alta.

🔧 NOTA

- Il montaggio e i collegamenti elettrici di questo prodotto richiedono competenza ed esperienza. Per garantire la massima sicurezza, affidare il montaggio e i collegamenti elettrici a tecnici qualificati.
- Collegare l'unità a massa ad un'alimentazione negativa a 12 V c.c.
- Non installare l'unità in un punto esposto alla luce solare diretta o a calore o umidità eccessivi. Evitare anche luoghi troppo polverosi o esposti a possibili spruzzi d'acqua.
- Non usare viti di tipo diverso; utilizzare soltanto quelle fornite in dotazione. L'uso di viti non idonee, potrebbe danneggiare l'unità.
- Se l'accensione della vettura non prevede la posizione ACC, collegare i cavi dell'accensione ad un'alimentazione commutabile mediante la chiave di accensione. Se si collega il cavo di accensione ad un'alimentazione a tensione costante, come i cavi della batteria, la batteria potrebbe scaricarsi.
- Se la console ha un coperchio, installare l'unità in modo che il frontalino non urti contro il coperchio durante l'apertura e la chiusura.
- In caso di intervento del fusibile, verificare prima se l'eventuale contatto dei cavi ha provocato un cortocircuito e quindi sostituire il fusibile con uno di capacità identica.
- Isolare i cavi scollegati con nastro vinilico o un materiale simile. Per evitare cortocircuiti, non rimuovere i cappucci alle estremità dei cavi scollegati o dei terminali.

Installazione

- Assicurare i cavi con dei morsetti e avvolgere del nastro vinilico attorno ai cavi che entrano in contatto con le parti in metallo per proteggerli e per evitare un corto circuito.
- Collegare correttamente i cavi degli altoparlanti ai corrispondenti terminali. L'unità potrebbe danneggiarsi o smettere di funzionare se si condividono i cavi ⊖ o se li si collega a qualsiasi parte metallica nel veicolo.
- Se al sistema sono collegati soltanto due altoparlanti, collegare i connettori ad entrambi i terminali di uscita anteriori o ad entrambi i terminali di uscita posteriori (non collegare contemporaneamente ai terminali anteriori e posteriori). Per esempio, se si collega il connettore ⊕ dell'altoparlante sinistro a un terminale di uscita frontale, non collegare il connettore ⊖ a un terminale di uscita posteriore.
- Dopo l'installazione dell'unità, controllare il corretto funzionamento di luci di arresto, lampeggiatori, tergicristalli, ecc.
- Montare l'unità con un'angolazione non superiore a 30°.
- Non premere con decisione sulla superficie del pannello durante l'installazione dell'unità sul veicolo, onde evitare possibili deformazioni, danni o anomalie.
- La presenza di oggetti metallici in prossimità dell'antenna Bluetooth può compromettere l'efficacia della ricezione.



■ Accessori in dotazione per l'installazione

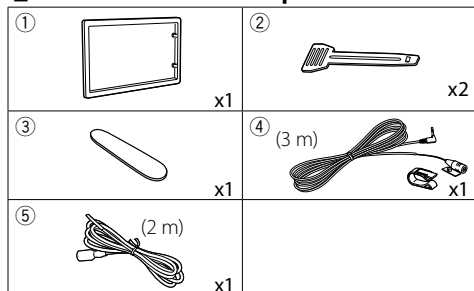

■ Procedura di installazione

- 1) Per evitare cortocircuiti, estrarre la chiave dall'accensione e scollegare il ⊖ morsetto della batteria.
- 2) Effettuare le corrette connessioni dei cavi in ingresso e in uscita da ciascuna unità.
- 3) Collegare il connettore ISO all'unità.
- 4) Installare l'unità sul veicolo.
- 5) Ricollegare il terminale ⊖ della batteria.
- 6) Premere il pulsante di ripristino.

Installazione dell'unità

■ Autovetture non giapponesi

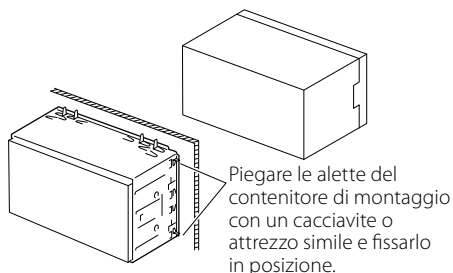

🔧 NOTA

- Verificare che l'unità sia saldamente installata in posizione. Se l'unità è instabile potrebbe non funzionare correttamente (ad esempio potrebbero verificarsi "salti" in fase di riproduzione).

■ Piastra di taglio

- 1) Fissare l'accessorio ① all'unità.

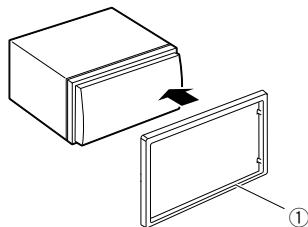

Installazione

Microfono

- 1) Controllare la posizione di installazione del microfono (accessorio ④).
- 2) Pulire la superficie di installazione.
- 3) Rimuovere il separatore del microfono (accessorio ④) e attaccare il microfono nel punto mostrato di seguito.
- 4) Collegare il cavo del microfono fino all'unità, fissandolo in vari punti con nastro adesivo o altri metodi di fissaggio.
- 5) Regolare la direzione del microfono (accessorio ④) rispetto al guidatore.

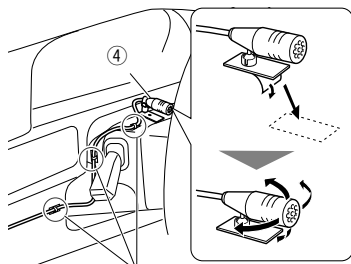

Fissare un cavo con un nastro normalmente reperibile in commercio.

NOTA

- Invertire i clip se necessario.



Rimozione della piastra di taglio

- 1) Utilizzare la chiave di estrazione (accessorio ③) per estrarre le quattro linguette (due sulla parte sinistra, due su quella destra).

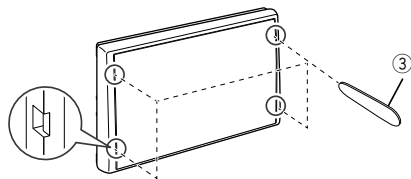

- 2) Tirare la piastra da taglio in avanti.

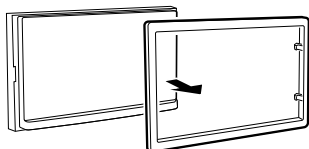

Rimozione dell'unità

- 1) Rimuovere la piastra di taglio facendo riferimento al passaggio 1 in "Rimozione della piastra di taglio".
- 2) Inserire la chiave di estrazione (accessorio ②) in profondità nella fessura come mostrato in figura. (La sporgenza sulla punta della chiave di estrazione deve trovarsi di fronte all'unità).

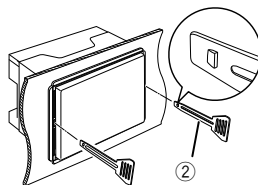

- 3) Con la chiave di estrazione inserita fissata, inserire l'altra chiave di estrazione nella fessura.

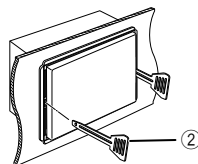

- 4) Estrarre per metà l'unità.

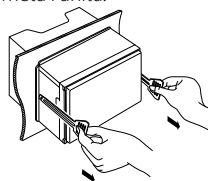

NOTA

- Fare attenzione a non ferirsi con i dadi di blocco sulla chiave di estrazione.
- 5) Estrarre completamente l'unità senza farla cadere.

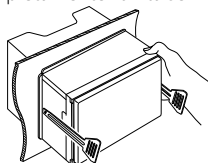

Installazione

Collegare i fili ai terminali

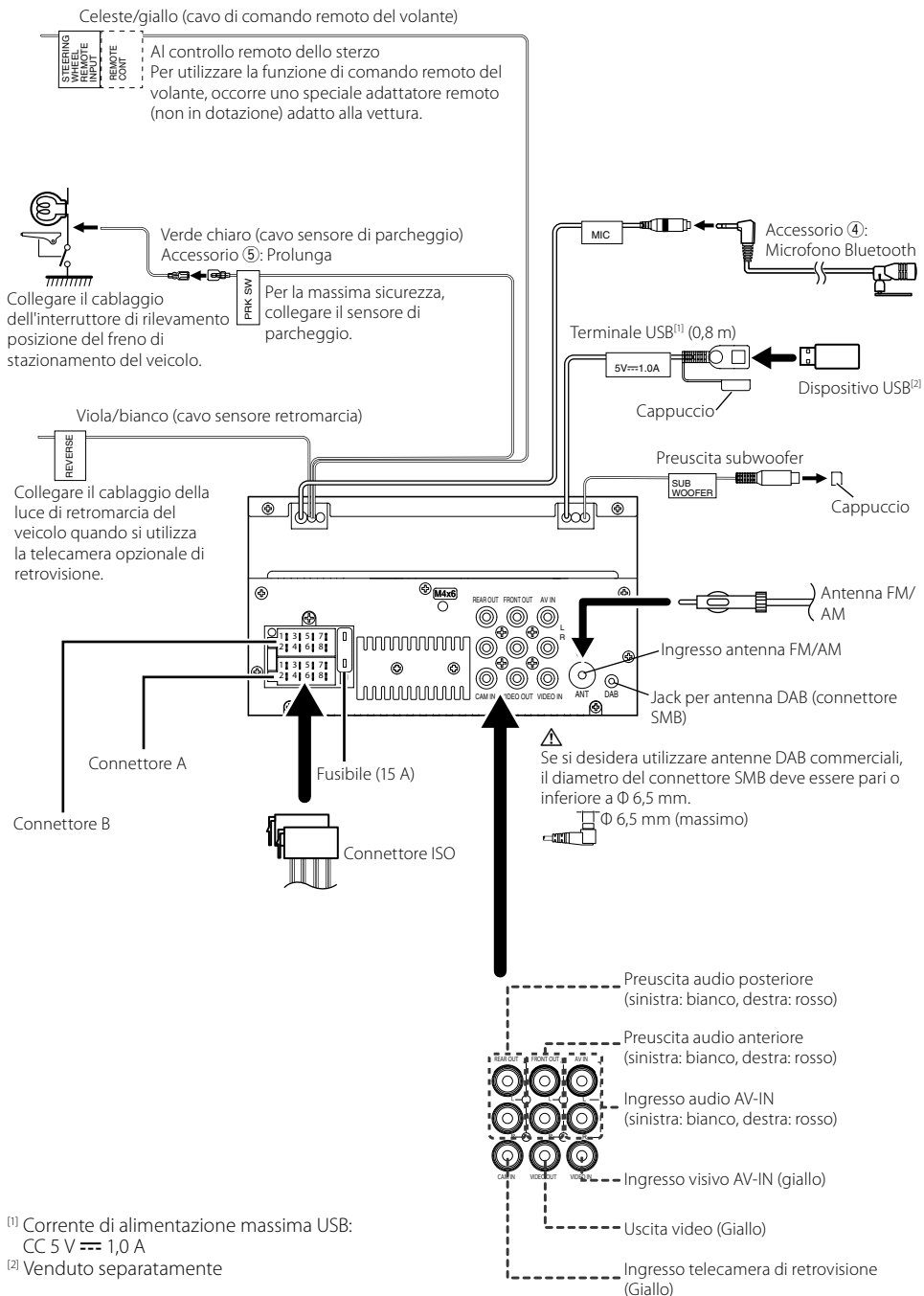

^[1] Corrente di alimentazione massima USB:
CC 5 V \approx 1,0 A

^[2] Venduto separatamente

Installazione

■ Guida alle funzioni dei connettori di cablaggio

Contatto	Colori e funzioni	
A-4	Giallo	Batteria
A-5	Blu/Bianco ^[1]	Comando alimentazione
A-7	Rosso	Accensione (ACC)
A-8	Nero	Collegamento a terra (massa)
B-1/B-2	Porpora (+) / viola/nero (-)	Posteriore destro
B-3/B-4	Grigio (+) / grigio/nero (-)	Anteriore destro
B-5/B-6	Bianco (+) / bianco/nero (-)	Anteriore sinistro
B-7/B-8	Verde (+) / verde/nero (-)	Posteriore sinistro

^[1] Max. 150 mA, 12 V

- Impedenza altoparlante: 4-8 Ω

⚠ ATTENZIONE

Prima di collegare i connettori ISO disponibili in commercio all'unità, controllare quanto segue:

- Assicurarsi che l'assegnazione del pin del connettore corrisponda all'unità JVC.
- Prestare molta attenzione al cavo di alimentazione.
- Nel caso in cui il cavo della batteria e il cavo di accensione non corrispondano, cambiarli.
- Nel caso in cui la macchina non disponga di un cavo di accensione, utilizzare un'interfaccia disponibile in commercio.

■ Connessione di un iPod/iPhone/ dispositivo Android

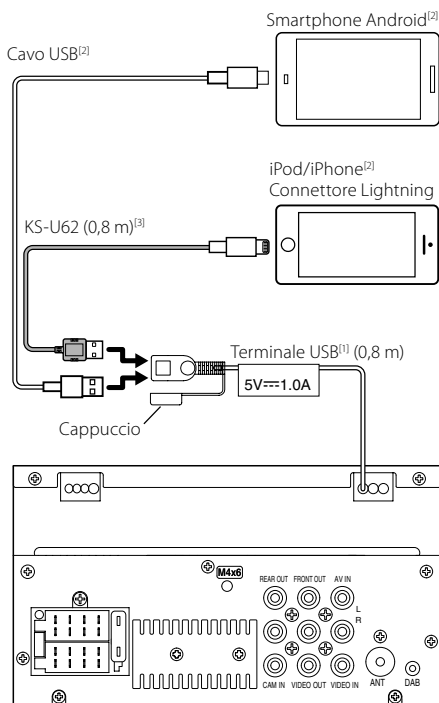

^[1] Corrente di alimentazione massima USB:
CC 5 V $\overline{=}$ 1,0 A

^[2] Venduto separatamente

^[3] Accessorio opzionale

Informazioni su questa unità

Ulteriori informazioni

Dispositivi USB utilizzabili

Questa unità può riprodurre file MPEG1/MPEG2/MPEG4/H.264/MKV/MP3/WMA/AAC/WAV/FLAC/OGG memorizzati in un dispositivo di archiviazione di massa USB.

- File system: FAT16/FAT32

NOTA

- Quando il dispositivo USB è collegato a quest'unità, può essere caricato mediante il cavo USB.
- Installare il dispositivo USB in un punto che non comprometta la sicurezza della guida.
- Non è possibile collegare un dispositivo USB attraverso un hub USB e un lettore multischede.
- Eseguire backup dei file audio usati con questa unità. I file potrebbero essere cancellati a seconda delle condizioni operative del dispositivo USB. Non è previsto nessun risarcimento per i danni derivanti dalla cancellazione dei dati.
- Nessun dispositivo USB è fornito in dotazione con questa unità. Il dispositivo USB deve essere acquistato separatamente.
- Mettere sempre il cappuccio al terminale USB quando non è in uso.

File audio riproducibili

Formato audio	Estensione
MP3	.mp3
WMA	.wma
AAC-LC	.m4a, .aac
PCM lineare (WAVE)	.wav
FLAC	.flac
Vorbis	.ogg

- Questa unità può visualizzare la versione Tag ID3 1.0/1.1/2.2/2.3/2.4 (per MP3).

NOTA

- I formati WMA e AAC protetti con sistema DRM non possono essere riprodotti.
- Anche se i file audio sono conformi agli standard elencati sopra, potrebbe essere impossibile riprodurli a seconda del tipo o delle condizioni del supporto o del dispositivo.

File video accettabili

Formato video	Estensione
MPEG-1	.mpg, .mpeg
MPEG-2	.mpg, .mpeg
MPEG-4	.mp4, .avi
H.264/MPEG-4 AVC	.mp4, .mkv, .avi, .flv, .f4v, .ts
MKV	.mkv

Nota per le specifiche

Sezione Bluetooth

Frequenza

: 2,402 – 2,480 GHz

Potenza di uscita

: +8 dBm (AVE), classe potenza 1

Gen.

Impedenza altoparlante

: 4 – 8 Ω

Tensione di esercizio

: Batteria auto da 12 V CC

Copyright

- La parola denominativa e i loghi Bluetooth® sono marchi di fabbrica registrati di proprietà di Bluetooth SIG, Inc. e il loro uso è concesso su licenza a JVCKENWOOD Corporation. Gli altri marchi e nomi commerciali sono di proprietà dei rispettivi proprietari.
- Use of the Made for Apple badge means that an accessory has been designed to connect specifically to the Apple product(s) identified in the badge and has been certified by the developer to meet Apple performance standards. Apple is not responsible for the operation of this device or its compliance with safety and regulatory standards. Please note that the use of this accessory with an Apple product may affect wireless performance.
- Apple, iPhone, iPod, iPod touch, and Lightning are trademarks of Apple Inc., registered in the U.S. and other countries.
- Microsoft and Windows Media are either registered trademarks or trademarks of Microsoft Corporation in the United States and/or other countries.
- THIS PRODUCT IS LICENSED UNDER THE MPEG-4 VISUAL PATENT PORTFOLIO LICENSE FOR THE PERSONAL AND NON-COMMERCIAL USE OF A CONSUMER FOR (j) ENCODING VIDEO IN COMPLIANCE WITH THE MPEG-4 VISUAL STANDARD ("MPEG-4 VIDEO") AND/OR (jj) DECODING MPEG-4 VIDEO THAT WAS ENCODED BY A CONSUMER ENGAGED IN A PERSONAL AND NON-COMMERCIAL ACTIVITY AND/OR WAS OBTAINED FROM A VIDEO PROVIDER LICENSED BY MPEG LA TO PROVIDE MPEG-4 VIDEO. NO LICENSE IS GRANTED OR SHALL BE IMPLIED FOR ANY OTHER USE. ADDITIONAL INFORMATION INCLUDING THAT RELATING TO PROMOTIONAL, INTERNAL AND COMMERCIAL USES AND LICENSING MAY BE OBTAINED FROM MPEG LA, LLC. SEE [HTTP://WWW.MPEGLA.COM](http://www.mpegla.com).
- THIS PRODUCT IS LICENSED UNDER THE AVC PATENT PORTFOLIO LICENSE FOR THE PERSONAL USE OF A CONSUMER OR OTHER USES IN WHICH IT DOES NOT RECEIVE REMUNERATION TO (j) ENCODE VIDEO IN COMPLIANCE WITH THE AVC STANDARD ("AVC VIDEO") AND/OR (jj) DECODE AVC VIDEO THAT WAS ENCODED BY

Informazioni su questa unità

A CONSUMER ENGAGED IN A PERSONAL ACTIVITY AND/OR WAS OBTAINED FROM A VIDEO PROVIDER LICENSED TO PROVIDE AVC VIDEO. NO LICENSE IS GRANTED OR SHALL BE IMPLIED FOR ANY OTHER USE. ADDITIONAL INFORMATION MAY BE OBTAINED FROM MPEG LA, L.L.C. SEE [HTTP://WWW.MPEGLA.COM](http://WWW.MPEGLA.COM)

• libFLAC

Copyright (C) 2000-2009 Josh Coalsou

Copyright (C) 2011-2013 Xiph.Org Foundation

– Redistribution and use in source and binary forms, with or without modification, are permitted provided that the following conditions are met:

– Redistributions of source code must retain the above copyright notice, this list of conditions and the following disclaimer.

– Redistributions in binary form must reproduce the above copyright notice, this list of conditions and the following disclaimer in the documentation and/or other materials provided with the distribution.

Neither the name of the Xiph.org Foundation nor the names of its contributors may be used to endorse or promote products derived from this software without specific prior written permission.

THIS SOFTWARE IS PROVIDED BY THE COPYRIGHT HOLDERS AND CONTRIBUTORS "AS IS" AND ANY EXPRESS OR IMPLIED WARRANTIES, INCLUDING, BUT NOT LIMITED TO, THE IMPLIED WARRANTIES OF MERCHANTABILITY AND FITNESS FOR A PARTICULAR PURPOSE ARE DISCLAIMED. IN NO EVENT SHALL THE FOUNDATION OR CONTRIBUTORS BE LIABLE FOR ANY DIRECT, INDIRECT, INCIDENTAL, SPECIAL, EXEMPLARY, OR CONSEQUENTIAL DAMAGES (INCLUDING, BUT NOT LIMITED TO, PROCUREMENT OF SUBSTITUTE GOODS OR SERVICES; LOSS OF USE, DATA, OR PROFITS; OR BUSINESS INTERRUPTION) HOWEVER CAUSED AND ON ANY THEORY OF LIABILITY, WHETHER IN CONTRACT, STRICT LIABILITY, OR TORT (INCLUDING NEGLIGENCE OR OTHERWISE) ARISING IN ANY WAY OUT OF THE USE OF THIS SOFTWARE, EVEN IF ADVISED OF THE POSSIBILITY OF SUCH DAMAGE.

• libogg

Copyright (c) 2002, Xiph.org Foundation Redistribution and use in source and binary forms, with or without modification, are permitted provided that the following conditions are met:

– Redistributions of source code must retain the above copyright notice, this list of conditions and the following disclaimer.

– Redistributions in binary form must reproduce the above copyright notice, this list of conditions and the following disclaimer in the documentation and/or other materials provided with the distribution.

– Neither the name of the Xiph.org Foundation nor the names of its contributors may be used to endorse or promote products derived from this software without specific prior written permission.

THIS SOFTWARE IS PROVIDED BY THE COPYRIGHT HOLDERS AND CONTRIBUTORS "AS IS" AND ANY EXPRESS OR IMPLIED WARRANTIES, INCLUDING, BUT NOT LIMITED TO, THE IMPLIED WARRANTIES OF MERCHANTABILITY AND FITNESS FOR A PARTICULAR PURPOSE ARE DISCLAIMED. IN NO EVENT SHALL THE FOUNDATION OR CONTRIBUTORS BE LIABLE FOR ANY DIRECT, INDIRECT, INCIDENTAL, SPECIAL, EXEMPLARY, OR CONSEQUENTIAL DAMAGES (INCLUDING, BUT NOT LIMITED TO, PROCUREMENT OF SUBSTITUTE GOODS OR SERVICES; LOSS OF USE, DATA, OR PROFITS; OR BUSINESS INTERRUPTION) HOWEVER CAUSED AND ON ANY THEORY OF LIABILITY, WHETHER IN CONTRACT, STRICT LIABILITY, OR TORT (INCLUDING NEGLIGENCE OR OTHERWISE) ARISING IN ANY WAY OUT OF THE USE OF THIS SOFTWARE, EVEN IF ADVISED OF THE POSSIBILITY OF SUCH DAMAGE.

■ Informazioni sull'eliminazione dei prodotti elettrici ed elettronici e delle batterie (per i paesi UE che adottano la raccolta differenziata dei rifiuti)

I prodotti e le batterie che recano questo simbolo (bidone della spazzatura barrato con una croce) non devono essere eliminati come rifiuti solidi urbani.

I vecchi prodotti elettrici ed elettronici e le batterie devono essere riciclati presso una apposita struttura in grado di trattare questi prodotti e di smaltirne i loro componenti.

Per i dettagli sulla posizione della struttura di riciclaggio più vicina, contattare l'autorità locale.

Se eseguiti correttamente, l'eliminazione e il riciclaggio di questi prodotti aiutano a conservare le risorse e a prevenire gli effetti nocivi sulla salute e l'ambiente.

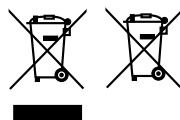

Contenido

Antes de la utilización	82
Cómo leer este manual	82
Precauciones	82
Inicio	83
Ajustes del reloj	83
Conceptos básicos	84
Funciones de los botones del panel frontal	84
Funciones habituales	84
Pantalla de INICIO	84
Pantalla de control de fuente	84
Radio digital	85
Funcionamiento básico de la radio digital	85
Configuración de la radio digital	85
Sintonizador	86
Funcionamiento básico del sintonizador	86
Configuración del sintonizador	86
USB	87
Preparativos	87
Operaciones de reproducción	87
iPod/iPhone	88
Preparativos	88
Operaciones de reproducción	88
Componentes externos	89
Uso de reproductores de audio/vídeo exteriores	89
Cámara de visión trasera	89
Control del audio	89
Controlar el audio general	89
Bluetooth	90
Registre su teléfono inteligente en la unidad	90
Reciba una llamada telefónica	90
Realice una llamada telefónica	90
Reproducir dispositivos de audio Bluetooth	91
Instalación	91
Antes de la instalación	91
Instalación de la unidad	92
Acerca de esta unidad	96
Más información	96
Nota para especificaciones	96
Derechos de autor	96

- Para obtener más detalles sobre la información de la guía y sobre las operaciones descritas, consulte el MANUAL DE INSTRUCCIONES en el siguiente sitio web:

<<https://www.jvc.net/cs/car/>>



Cómo leer este manual

- Los paneles que se incluyen en este manual son ejemplos utilizados para ofrecer explicaciones de las distintas operaciones. Por esta razón, pueden diferir de los paneles que se visualizan en realidad.
- En los procedimientos operativos, las llaves indican la tecla o botón que debe emplear.
 - < >: indica el nombre de los botones del panel.
 - []: Indica el nombre de las teclas.

Antes de la utilización

Precauciones

▲ ADVERTENCIA

■ Para evitar lesiones o incendios, tome las precauciones siguientes:

- Para evitar un cortocircuito, nunca coloque ni deje objetos metálicos (como monedas o herramientas metálicas) dentro de la unidad.
- No mire fijamente la pantalla de la unidad mientras está conduciendo durante un periodo prolongado de tiempo.
- Si tiene problemas durante la instalación, consulte con su distribuidor JVC.

■ Precauciones para el uso de esta unidad

- Cuando compre accesorios opcionales, pregunte a su distribuidor JVC si dichos accesorios son compatibles con su modelo y en su región.
- La función Radio Data System o Radio Broadcast Data System no funcionará en lugares donde no existan emisoras compatibles con este servicio.

■ Cómo proteger el monitor

- Para proteger el monitor de posibles daños, no lo utilice con un bolígrafo con punta de bola o una herramienta similar con una punta afilada.

■ Limpieza de la unidad

Si el panel frontal de esta unidad está manchado, límpielo con un paño suave y seco, como por ejemplo, un paño de silicona. Si el panel frontal está muy manchado, limpie la mancha con un paño humedecido con un producto de limpieza neutro y, a continuación, vuelva a limpiarlo con un paño suave, limpio y seco.

▲ PRECAUCIÓN

- Aplicar un limpiador en spray directamente sobre la unidad, puede dañar sus componentes mecánicos. Limpiar el panel frontal con un paño áspero o con un líquido volátil, como un disolvente o alcohol, podría rayar la superficie o borrar las impresiones de la pantalla.

■ Cómo reiniciar la unidad

Si la unidad o la unidad conectada no funcionan correctamente, reiniciela.

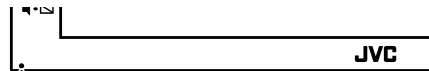

Botón Restablecer



Este símbolo fijado en el producto indica que hay instrucciones importantes de operación y mantenimiento en este manual. Asegúrese de leer cuidadosamente las instrucciones de este manual.

Inicio

1 Coloque la llave de encendido del coche en la posición ACC.

La unidad se pone en marcha.

2 Pulse el botón <🏠>.

3 Toque [⚙️].



4 Toque la tecla correspondiente y establezca un valor.

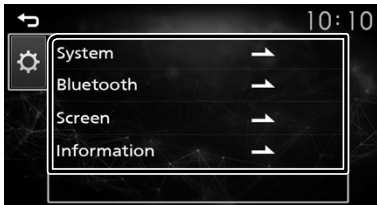

[System]

[Beep Tone]

Activa o desactiva el tono de las teclas. "ON" (ACTIVADO) (Predeterminado), "OFF" (DESACTIVADO)

[Language]

Seleccione el idioma utilizado para la pantalla de control y los elementos de configuración. El idioma predeterminado es "English".

[Time/Date]

Ajuste la hora del reloj. (P.83)

[Clock Mode]

Seleccione el formato de visualización de la hora. [12hr]/[24hr] (predeterminado)

[Parking Guidelines]

Podrá visualizar las pautas de parking para permitir un parking más sencillo al engranar la marcha a la posición de marcha atrás (R). La opción predeterminada es "ON".

[Guidelines SETUP]

Si selecciona [ON] para [Parking Guidelines], puede ajustar las pautas de aparcamiento.

[System Reset]

Toque [System Reset] y después toque [YES] para establecer todos los ajustes en los ajustes iniciales predeterminados.

[Bluetooth]

Muestra la pantalla Configuración de Bluetooth.

[Screen]

[Dimmer]

Seleccione el modo de atenuación. "High" (predeterminado)/"Mid"/"Low"

[Demo]

Seleccione el modo de demostración. La opción predeterminada es "ON".

[Information]

Muestra la versión de software de esta unidad.

5 Toque [↩️].

Ajustes del reloj

■ Sincronización de la hora del reloj con FM RDS

Active [RDS Clock Sync].

Consulte **Configuración del sintonizador (P.86)**.

■ Ajuste del reloj manualmente

🔑 NOTA

- Desactive [RDS Clock Sync] antes de ajustar el reloj.

1 Pulse el botón <🏠>.

2 Toque [⚙️].

3 Toque [System].

4 Toque [Time/Date].

Aparece la pantalla del reloj.

5 Toque el botón [▲] o [▼] para ajustar la hora del reloj.



6 Toque [↩️].

Conceptos básicos

Funciones de los botones del panel frontal

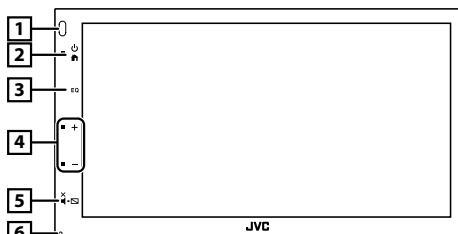

1 Sensor remoto

- Recibe la señal del control remoto.

2 (INICIO)

- Muestra la pantalla INICIO. **(P.84)**
- Si se pulsa durante 1 segundo, se apaga la unidad.
- Si la unidad está apagada, la enciende.

3 EQ

- Muestra la pantalla Audio.* **(P.89)**
- * La pantalla Audio no se muestra mientras está en la pantalla CONFIGURACIÓN o en la pantalla de lista.

4 +, - (Volumen)

- Ajusta el volumen. Si continúa presionando [+] el volumen aumentará hasta 20.

5 (MUTE, Pantalla desactivada)

- Silencia/restablece el sonido.
- Al pulsar durante 1 segundo se apaga la pantalla. Cuando la pantalla esté apagada, toque la pantalla para encender la misma.

6 Restablecer

- Si la unidad o el equipo conectado no funcionan correctamente, la unidad restablece la configuración de fábrica al pulsar este botón.

Funciones habituales

Encendido

- 1 Pulse el botón



Apagado

- 1 Pulse y mantenga pulsado el botón

Pantalla de INICIO

- 1 Pulse el botón .

Aparece la pantalla HOME (inicio).



- 1 Pantalla del reloj

- 2 Cambia a la emisión del programa de radio. **(P.86)**

- 3 [USB]

Reproduce archivos en un dispositivo USB. **(P.87)**

- [iPod]

Reproduce un iPod/iPhone. **(P.88)**

- Cuando está conectado un iPod/iPhone.

- [Mirroring]

Muestra la pantalla Réplica.

- Cuando se conecta un dispositivo Android con la aplicación "Mirroring OB for JVC" instalada.

- 4 Cambia a un componente externo conectado al terminal de entrada AV-IN. **(P.89)**

- 5 Muestra la pantalla Manos libres. **(P.90)**

- 6 Reproduce el reproductor de audio Bluetooth. **(P.91)**

- 7 Cambia a la emisión de radio digital. **(P.85)**

- 8 Muestra la pantalla CONFIGURACIÓN. **(P.83)**

Pantalla de control de fuente



- 1 : Regresa a la pantalla anterior.

: Muestra la pantalla Audio. **(P.89)**

Radio digital

Funcionamiento básico de la radio digital

1 Pulse el botón <🏠>.

2 Toque [Digital Radio].

■ Pantalla de control de fuente



1 Muestra la información del servicio actual:

Nombre del servicio, Nombre del conjunto, Género PTY, Canal

2 **[DAB]**: Cambia la banda predefinida de Radio digital.

"DAB1", "DAB2", "DAB3"

[DLS]: Visualice la pantalla Segmento de etiqueta dinámica.

[◀▶]: Seleccione un conjunto, un servicio y un componente.

[☰]: Muestra la pantalla Configuración de la radio digital. **(P.85)**

3 Restaura el servicio memorizado.

Si se toca durante 2 segundos, almacena en la memoria el servicio de recepción actual.

■ Almacenar un servicio

El servicio que se está recibiendo actualmente puede almacenarse en la memoria.

1 Sintone el servicio que desea preestablecer.

2 Mantenga pulsado el [#] (#:1-5) en el que desee guardar el servicio.

■ Seleccionar un servicio almacenado

1 Toque [#] (#:1-5).

Configuración de la radio digital

1 Toque [☰].

2 Ajuste cada elemento del modo siguiente.



[Service List]

Muestra la pantalla Lista de servicios.

- **[🔄]**: Toque y luego toque [YES] para encontrar la lista de servicios más reciente.

[TI]

Cambia a la información de tráfico automáticamente cuando empieza el boletín de tráfico.

"ON" (ACTIVADO), "OFF" (DESACTIVADO) (predeterminado)

[PTY]

Busca un programa por tipo de programa.

[Priority]

Si se ofrece el mismo servicio por sistema de datos de radio cuando la recepción por radio digital empeora, se cambia automáticamente a sistema de datos de radio.

"ON" (ACTIVADO), "OFF" (DESACTIVADO) (predeterminado)

[Announcement Select]

Cambia al servicio de anuncio seleccionado.

[Related Service]

Al seleccionar ON (encendido), la unidad cambia a un servicio relacionado (si existe) cuando una red de servicio DAB no esté disponible. La opción predeterminada es "OFF".

[Antenna Power]

Ajusta la alimentación de la antena de radio digital. Seleccione "ON" si la antena de radio digital que utiliza está equipada con amplificador. La opción predeterminada es "ON".

3 Toque [↩].

Sintonizador

Funcionamiento básico del sintonizador

- 1 Pulse el botón .
- 2 Toque [Tuner].

Pantalla de control de fuente

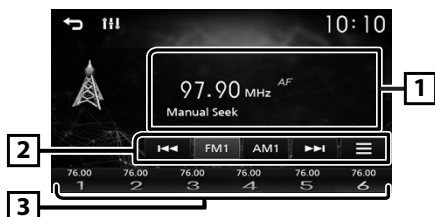

- 1 Muestra información sobre la emisora actual: Nombre PS, Frecuencia, Género PTY, Elementos del indicador
- 2 **[FM]**: Cambia la frecuencia FM.
"FM1", "FM2", "FM3"
[AM]: Cambia la frecuencia AM.
"AM1", "AM2"
[◀▶]: Sintoniza automáticamente una emisora con buena recepción.
[☰]: Muestra la pantalla CONFIGURACIÓN del sintonizador. **(P.86)**
- 3 Restaura la emisora memorizada.
Si se toca durante 2 segundos, almacena en la memoria la emisora de recepción actual.

Memoria automática

Puede presintonizar 6 emisoras para la banda actual (FM1/FM2/FM3/AM1/AM2).

- 1 Toque [FM] o [AM] para seleccionar la frecuencia.
- 2 Toque [☰].
- 3 Toque [Auto Store].
Las emisoras locales con las señales más fuertes se encuentran y almacenan automáticamente.

Memoria manual

Puede almacenar en la memoria la emisora que está recibiendo actualmente.

- 1 Sintonice una emisora que desea preestablecer.
- 2 Mantenga pulsado [#] (#:1-6) en el que desee guardar la emisora.

Volver a una emisora prefijada

- 1 Toque [#] (#:1-6).

Configuración del sintonizador

- 1 Toque [☰].
- 2 Ajuste cada elemento del modo siguiente.

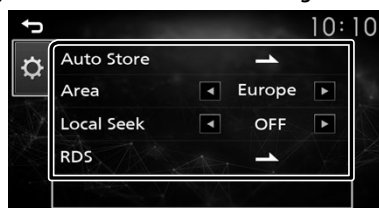

[Auto Store]

Busca y almacena automáticamente las 6 estaciones con las señales más fuertes para la banda seleccionada.

Aparece "Auto Store" (guardar automáticamente).

[Local Seek]

Sintoniza solo las emisoras con una fuerza de señal suficiente. (Se ilumina el indicador **LOC**).

"ON" (ACTIVADO), "OFF" (DESACTIVADO)
(predeterminado)

[RDS] *1

Muestra la pantalla Configuración de RDS.

[AF]

Si la recepción de una emisora es deficiente, se cambia automáticamente a la emisora que esté emitiendo el mismo programa a través de la misma red de Radio Data System.

"ON" (ACTIVADO) (Predeterminado), "OFF" (DESACTIVADO)

[TA]

Cambia a la información de tráfico automáticamente cuando empieza el boletín de tráfico. (Se ilumina el indicador **TI**).

"ON" (ACTIVADO), "OFF" (DESACTIVADO)
(predeterminado)

[RDS Clock Sync]

Sincronización mediante el Sistema de datos de radio de los datos horarios de la emisora y el reloj de esta unidad.

"ON" (ACTIVADO) (Predeterminado), "OFF" (DESACTIVADO)

[PTY]

Seleccione un tipo de programa.

[PTY Seek]

Busca un programa por tipo de programa.

*1 Solo FM

- 3 Toque [↩].

USB

Preparativos

■ Conexión de un dispositivo USB

- 1 Retire la tapa del terminal de USB.
- 2 Conecte el dispositivo USB con el cable USB.

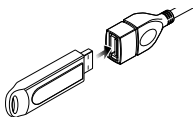

La unidad lee el dispositivo y se inicia la reproducción.

■ Para desconectar el dispositivo USB:

- 1 Pulse el botón .
- 2 Toque una fuente distinta de [USB].
- 3 Desconecte el dispositivo USB.

■ Dispositivos USB que pueden utilizarse

Esta unidad puede reproducir archivos MPEG1/MPEG2/MPEG4/H.264/MKV/MP3/WMA/AAC/WAV/FLAC/OGG guardados en un dispositivo de almacenamiento masivo USB.

Operaciones de reproducción

■ Controle la música que está escuchando en la pantalla de control de fuente.



- 1 Se muestra la cubierta de la emisora que se está escuchando en ese momento.
- 2 Muestra la información del archivo actual.
- 3 Tiempo de reproducción/Número de archivo
Barra de tiempo de la reproducción: Para confirmar la posición actual de la reproducción.
- 4 []: Selecciona el modo Reproducción aleatoria.
[]: Selecciona el modo de reproducción Repetir.
[], []: Reproduce o pausa.

- [], []: Busca el contenido anterior/siguiente.
Mantenga pulsado para avanzar o retroceder rápidamente.
- []: Busca el archivo. (P.87)

■ Para la reproducción de video

- 1 Si los botones de operación no se visualizan en la pantalla, toque la pantalla.

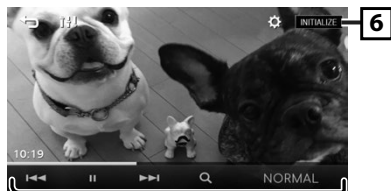

- 6 []: Puede ajustar la calidad de la imagen en la pantalla de video.
[INITIALIZE]: Para eliminar el ajuste.
- 7 [], []: Reproduce o pausa.
[], []: Busca el contenido anterior/siguiente.
Mantenga pulsado para avanzar o retroceder rápidamente.
[]: Busca el archivo. (P.87)
[NORMAL]/[16:9]/[4:3]: Selecciona un modo de pantalla.

■ Selección de una pista en una lista (búsqueda de archivo)

- 1 Toque [].
 - 2 Seleccione si desea realizar la búsqueda por archivo de audio [] o por archivo de vídeo [].
 - 3 Toque [] para desplazarse a la jerarquía superior.
 - 4 Toque la carpeta deseada.
Al tocar una carpeta, se muestran sus contenidos.
• Toque [] para desplazarse a la jerarquía superior.
 - 5 Toque para seleccionar el elemento en la lista de contenidos.
La reproducción se inicia.
- NOTA**
- Aparece la pantalla de control de la fuente cuando toca [] en la parte superior de la jerarquía.

Preparativos

■ Conexión de iPod/iPhone

- Para modelos con conector Lightning: Use el cable de audio USB para iPod/iPhone—KS-U62 (accesorio opcional).
- Para obtener detalles acerca de la conexión de un iPod/iPhone, consulte la página 95 .

1 Retire la tapa del terminal de USB.

2 Conecte el iPod/iPhone.

La unidad lee el dispositivo y se inicia la reproducción.

■ Para desconectar el iPod/iPhone

1 Pulse el botón <🏠>.

2 Toque una fuente distinta de [iPod].

3 Desconecte el iPod/iPhone.

■ iPod/iPhone que pueden conectarse

Los siguientes modelos pueden conectarse a esta unidad.

Fabricados para

- | | | |
|------------------------------|---------------------|------------------|
| • iPhone 12 Pro Max | • iPhone 11 Pro Max | • iPhone 8 Plus |
| • iPhone 12 Pro | • iPhone 11 Pro | • iPhone 8 |
| • iPhone 12 | • iPhone 11 | • iPhone 7 Plus |
| • iPhone 12 mini | • iPhone XS Max | • iPhone 7 |
| • iPhone SE (2nd generation) | • iPhone XS | • iPhone SE |
| | • iPhone XR | • iPhone 6s Plus |
| | • iPhone X | • iPhone 6s |
| | | • iPhone 6 Plus |

📎 NOTA

- Si empieza la reproducción después de conectar el iPod, se reproducirá primero la música reproducida por el iPod.
- Tape la terminal de USB cuando no se esté utilizando.

Operaciones de reproducción

■ Controle la música que está escuchando en la pantalla de control de fuente.



1 Material gráfico (se muestra si la pista contiene material gráfico)

2 Muestra la información del archivo actual.

3 Tiempo de reproducción/Número de archivo
Barra de tiempo de la reproducción: Para confirmar la posición actual de la reproducción.

4 [⏮]: Seleccióna el modo Reproducción aleatoria.

[🔀]: Seleccióna el modo de reproducción Repetir.

[▶], [⏸]: Reproduce o pausa.

[⏪], [⏩]: Busca el contenido anterior/siguiente.
Mantenga pulsado para avanzar o retroceder rápidamente.

[🔍]: Busca contenido. **(P.88)**

■ Seleccione un contenido en una lista

1 Toque [🔍].

2 Toque el elemento deseado.

Cuando toca una categoría, se muestran sus contenidos.

3 Toque para seleccionar el elemento en la lista de contenidos.

La reproducción se inicia.

- Toque [↶] para desplazarse a la jerarquía superior.

📎 NOTA

- Aparece la pantalla de control de la fuente cuando toca [↶] en la parte superior de la jerarquía.

Componentes externos Control del audio

Uso de reproductores de audio/vídeo exteriores

Inicio de la reproducción

- 1 Conecte un componente externo a la terminal de entrada AV-IN. (P.94)
- 2 Pulse el botón <HOME>.
- 3 Toque [AV-IN].
- 4 Enciende el componente conectado y comienza a reproducir la fuente.

Para la reproducción de video

- 1 Si los botones de operación no se visualizan en la pantalla, toque la pantalla.

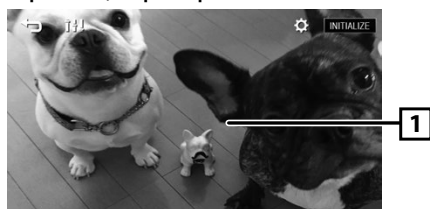

Cámara de visión trasera

Para usar una cámara de visión trasera, se requiere la conexión del cable de MARCHA ATRÁS. Para conectar una cámara de visión trasera. (P.94)

Visualización de la imagen desde la cámara de visión trasera

Se muestra la pantalla de visión trasera cuando cambia la palanca de cambios a la posición de marcha atrás (R).



- Para eliminar el mensaje de precaución, toque la pantalla.

Puede ajustar diversas opciones como el balance de audio o el subwoofer.

- 1 Pulse el botón <EQ>.
- 2 Consulte la información siguiente para cada método de funcionamiento.

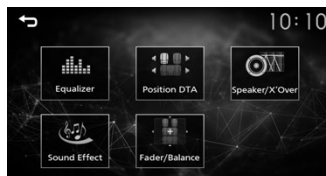

Controlar el audio general

- 1 Pulse el botón <EQ>.
- 2 Toque [Fader / Balance].
- 3 Ajuste cada elemento del modo siguiente.



[Fader Balance]

Balance Ajuste el balance del volumen izquierdo y derecho.
[▶] [◀]
De 15 (derecha) a 15 (izquierda)

Fader Ajuste el balance del volumen delantero y trasero.
[▲] [▼]
De 15 (delantero) a 15 (trasero)

[INITIALIZE] Para eliminar el ajuste.

Bluetooth

Registre su teléfono inteligente en la unidad

Puede utilizar su teléfono inteligente Bluetooth cuando esté emparejado con esta unidad.

- 1 Active la función Bluetooth en su teléfono inteligente/teléfono móvil.
- 2 Busque la unidad ("KW-M27DBT") en su teléfono inteligente/teléfono móvil.
Si se requiere un código PIN, introduzca el código PIN ("0000").
 -  aparece cuando el teléfono inteligente Bluetooth está conectado.

Desconexión del dispositivo

- Desactive la función Bluetooth en su teléfono inteligente/teléfono móvil.
- Apague el interruptor de encendido.

Reciba una llamada telefónica

1 Toque [📞].

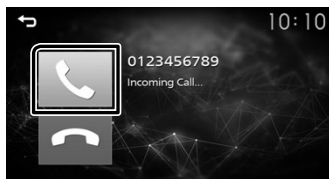

- [📞]: Rechace una llamada entrante.

Operaciones durante una llamada

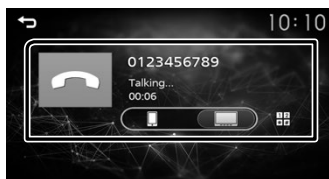

- [📞] Finalización de una llamada
- [1 2] Puede enviar tonos tocando las teclas correspondientes de la pantalla.
 - Toque [🔙] para cerrar la ventana.
- [📞] Cambia la salida de voz entre el teléfono inteligente/móvil y el altavoz.

Ajustar el volumen del receptor

Pulse el botón < + > o < - >.

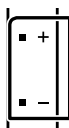

Realice una llamada telefónica

- 1 Pulse el botón < 🏠 >.
- 2 Toque [Phone].
- 3 Consulte la tabla de abajo para cada método de funcionamiento.

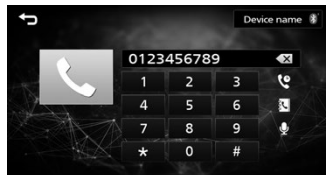

Llamar introduciendo un número telefónico

- 1) Introducir un número de teléfono con las teclas numéricas.
- 2) Toque [📞].
Haga una llamada
 - Toque [✖] para borrar la última entrada.

Llamar usando datos de llamada almacenados

- 1) Toque [📞].
- 2) Toque [📞] (llamadas entrantes), [📞] (llamadas salientes), [📞] (llamadas perdidas).
- 3) Seleccione el número de teléfono de la lista.
Haga una llamada

Llamar usando la agenda telefónica

- 1) Toque [📞].
- 2) Seleccione el nombre de la lista.
Haga una llamada
 - [🔄]: Actualiza la agenda. Toque este botón después de que haya realizado un cambio en la agenda de su teléfono inteligente/móvil.

Bluetooth

Reproducir dispositivos de audio Bluetooth

1 Pulse el botón <🏠>.

2 Toque [BT Audio].

■ Pantalla de control de fuente



- 1 Muestra la información del archivo actual.
- 2 Tiempo de reproducción/Número de archivo
Barra de tiempo de la reproducción: Para confirmar la posición actual de la reproducción.

- 3 [🔍] : Selecciona el modo Reproducción aleatoria.
[🔄] : Selecciona el modo de reproducción Repetir.
[▶], [⏸] : Reproduce o pausa.
[◀], [▶] : Busca el contenido anterior/siguiente.
Mantenga pulsado para avanzar o retroceder rápidamente.
[Q] : Busca el archivo. (P.91)

🔧 NOTA

- Las operaciones y las indicaciones en pantalla pueden variar en función de su disponibilidad en el dispositivo conectado.

■ Seleccione un contenido en una lista

1 Toque [Q].

2 Toque el elemento deseado.

Cuando toca una categoría, se muestran sus contenidos.

3 Toque para seleccionar el elemento en la lista de contenidos.

La reproducción se inicia.

- Toque [↶] para desplazarse a la jerarquía superior.

🔧 NOTA

- Aparece la pantalla de control de la fuente cuando toca [↷] en la parte superior de la jerarquía.

Instalación

Antes de la instalación

Antes de la instalación de esta unidad, tenga en cuenta las precauciones siguientes.

⚠️ ADVERTENCIAS

- Si conecta el cable de encendido (rojo) y el cable de la batería (amarillo) al chasis del automóvil (tierra), podría producir un cortocircuito y esto, a su vez, un incendio. Conecte siempre esos cables a la fuente de alimentación que pasa por la caja de fusibles.
- No corte el fusible del cable de ignición (rojo) y el cable de la batería (amarillo). El suministro de energía debe conectarse a los cables por medio del fusible.

⚠️ PRECAUCIÓN

- Instale esta unidad en la consola de su vehículo. No toque la parte metálica de esta unidad durante e inmediatamente después del uso de la unidad. Las partes metálicas, tales como el disipador de calor o la carcasa, pueden estar muy calientes.

🔧 NOTA

- La instalación y el cableado de este producto requieren habilidad y experiencia. Para mayor seguridad, deje el trabajo de montaje y cableado en manos de profesionales.
- Asegúrese de utilizar para la unidad una fuente de alimentación de 12 V CC con conexión a tierra negativa.
- No instale la unidad en un sitio expuesto a la luz directa del sol, o excesivamente húmedo o caluroso. Además deberá evitar sitios con mucho polvo o con posibilidad de salpicaduras de agua.
- No utilice sus propios tornillos. Utilice solo los tornillos suministrados. El uso de tornillos diferentes podría causar daños en la unidad.
- Si el encendido de su automóvil no está provisto de la posición ACC, conecte los cables de encendido a una fuente de alimentación que pueda conectarse y desconectarse con la llave de encendido. Si conecta el cable de encendido a una fuente de alimentación con un suministro de voltaje constante, como con los cables de la batería, la batería puede agotarse.
- Si la consola tiene una tapa, asegúrese de instalar la unidad de forma que el panel frontal no golpee la tapa al abrirse o cerrarse.
- Si se funden los fusibles, asegúrese primero de que los cables no están en contacto pues pueden ocasionar un cortocircuito, luego reemplace el fusible dañado por uno nuevo que tenga la misma potencia de servicio.
- Aísle los cables no conectados con una cinta de vinilo u otro material similar. Para evitar cortocircuitos, no retire las tapas de los extremos de los cables o terminales no conectados.

Instalación

- Asegure los cables con las abrazaderas de cable y envuelva cinta de vinilo alrededor de los cables que entren en contacto con los elementos metálicos para proteger los cables y para evitar cortocircuitos.
- Conecte los cables de los altavoces a cada uno de los terminales correspondientes. La unidad se puede dañar o no funcionar si comparte los cables \ominus o los conecta a tierra a cualquier parte metálica del vehículo.
- Si se han conectado solamente dos altavoces al sistema, enchufe los conectores a ambos terminales de salida delanteros o a ambos terminales de salida traseros (es decir, no mezcle terminales delanteros y traseros). Por ejemplo, si conecta el conector \oplus del altavoz izquierdo a un terminal de salida delantero, no conecte el conector \ominus a un terminal de salida posterior.
- Después de instalar la unidad, compruebe que las luces de freno, las luces intermitentes, el limpiaparabrisas, etc. funcionan satisfactoriamente.
- Instale la unidad en un ángulo de 30° o menos.
- No presione con fuerza la superficie del panel al instalar la unidad en el vehículo. De lo contrario, pueden producirse marcas, daños o fallos.
- La recepción podría ser baja si existen objetos metálicos cerca de la antena Bluetooth.



■ Accesorios suministrados para la instalación

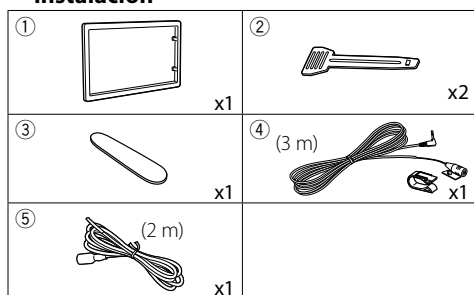

■ Procedimiento de instalación

- 1) Para evitar cortocircuitos, retire la llave del encendido y desconecte el terminal \ominus de la batería.
- 2) Realice de forma adecuada las conexiones de cables de entrada y salida para cada unidad.
- 3) Conecte el conector ISO a la unidad.
- 4) Instale la unidad en el automóvil.
- 5) Conecte nuevamente el terminal \ominus de la batería.
- 6) Pulse el botón Restablecer.

■ Instalación de la unidad

■ Coches no japoneses

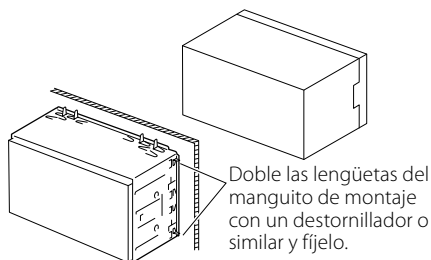

🔧 NOTA

- Asegúrese de que la unidad esté firmemente instalada en su lugar. Si la unidad está en una posición inestable, es posible que no funcione correctamente (por ejemplo, el sonido puede interrumpirse).

■ Placa

- 1) Conecte el accesorio ① a la unidad.

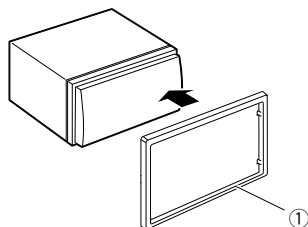

Instalación

■ Unidad de micrófono

- 1) Compruebe la posición de instalación del micrófono (accesorio ④).
- 2) Limpie la superficie de instalación.
- 3) Extraiga el separador del micrófono (accesorio ④) y fije el micrófono en la posición indicada más abajo.
- 4) Conecte el cable del micrófono a la unidad de forma segura en varias posiciones mediante cinta u otro método.
- 5) Ajuste la dirección del micrófono (accesorio ④) hacia el conductor.

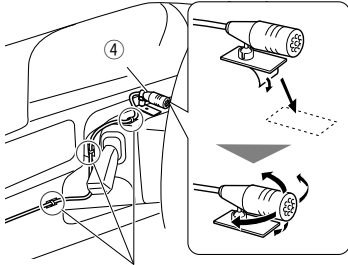

Fije un cable con una cinta adhesiva de uso comercial.

📎 NOTA

- Cambie los clips si es necesario.

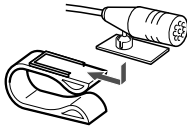

■ Retirada del marco

- 1) Use la tecla de extracción (accesorio ③) para extraer las cuatro pestañas (dos en la parte izquierda, dos en la parte derecha).

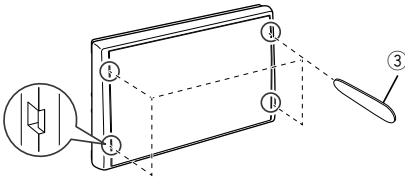

- 2) Tire de la placa hacia adelante.

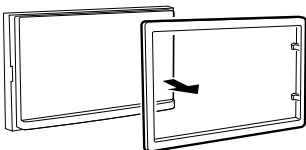

■ Desmontaje de la unidad

- 1) Retire el marco según las indicaciones del paso 1 de "Retirada del marco".
- 2) Introduzca la llave de extracción (accesorio ②) profundamente en la ranura tal y como se muestra. (El saliente en la punta de la tecla de extracción debe mirar hacia la unidad).

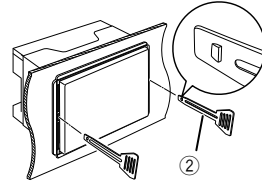

- 3) Con la llave de extracción introducida asegurada, inserte la otra llave de extracción en la ranura.

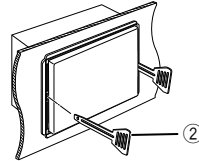

- 4) Saque la unidad hasta la mitad.

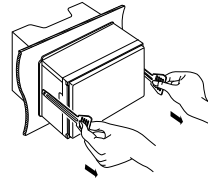

📎 NOTA

- Tenga cuidado de no hacerse daño con los pasadores de bloqueo de la llave de extracción.
- 5) Termine de sacar la unidad con las manos, prestando atención para no dejarla caer.

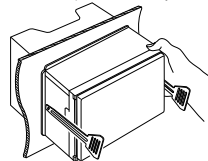

Instalación

Conectar los cables a los terminales

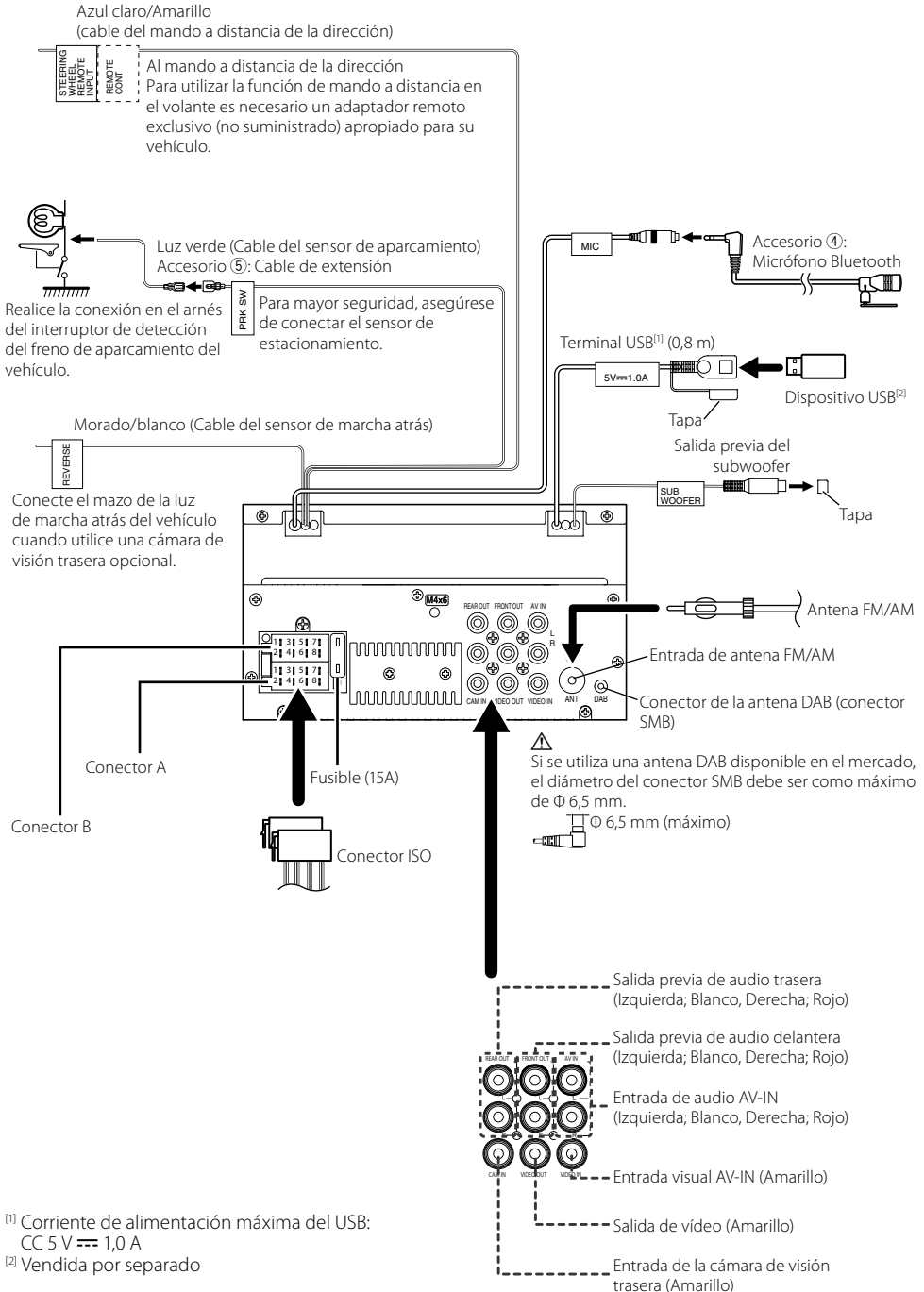

^[1] Corriente de alimentación máxima del USB:
 CC 5 V = 1,0 A

^[2] Vendida por separado

Instalación

■ Guía de funciones de los conectores del mazo de cables

Patilla	Color y función	
A-4	Amarillo	Batería
A-5	Azul/Blanco ^[1]	Control de alimentación
A-7	Rojo	Encendido (ACC)
A-8	Negro	Conexión a tierra (masa)
B-1/ B-2	Púrpura (+) / Púrpura/Negro (-)	Trasero derecho
B-3/ B-4	Gris (+) / Gris/Negro (-)	Delantero derecho
B-5/ B-6	Blanco (+) / Blanco/Negro (-)	Delantero izquierdo
B-7/ B-8	Verde (+) / Verde/Negro (-)	Trasero izquierdo

^[1] Máx. 150 mA, 12 V

- Impedancia del altavoz: 4-8 Ω

⚠ PRECAUCIÓN

Antes conectar los conectores ISO disponibles comercialmente a la unidad, compruebe la siguiente condición:

- Asegúrese que la asignación de clavijas del conector coincide con la unidad JVC.
- Tome precauciones extra con el cable de alimentación.
- In caso de que el cable de la batería y el cable de encendido no correspondan, entonces cámbielos según corresponda.
- En caso de que el coche no tenga un cable de encendido, use una interfaz disponible comercialmente.

■ Conexión de un iPod/iPhone/Android

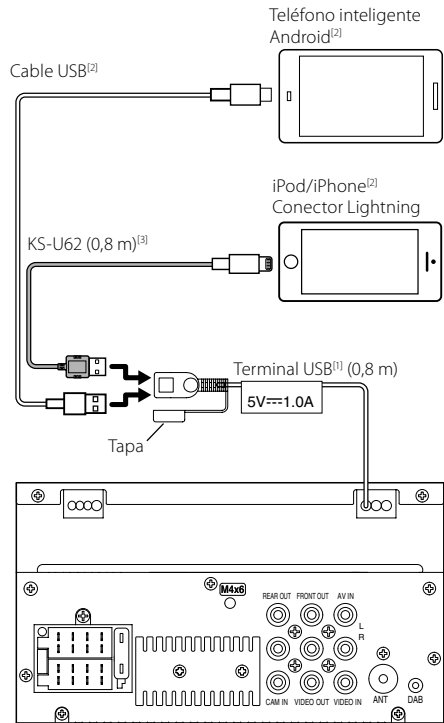

^[1] Corriente de alimentación máxima del USB:
CC 5 V --- 1,0 A

^[2] Vendida por separado

^[3] Accesorio opcional

Acerca de esta unidad

Más información

Dispositivos USB que pueden utilizarse

Esta unidad puede reproducir archivos MPEG1/MPEG2/MPEG4/H.264/MKV/MP3/WMA/AAC/WAV/FLAC/OGG guardados en un dispositivo de almacenamiento masivo USB.

- Sistema de archivo: FAT16/ FAT32

NOTA

- Cuando el dispositivo USB esté conectado a esta unidad, puede cargarse a través del cable USB.
- Instale el dispositivo USB en un lugar que no perjudique a una conducción segura.
- No puede conectar un dispositivo USB mediante un núcleo USB o un lector de tarjetas múltiple.
- Haga copias de seguridad de los archivos de audio utilizados con esta unidad. Los archivos podrían borrarse en función de las condiciones de funcionamiento del dispositivo USB. No compensaremos en forma alguno los daños producidos por cualquier dato borrado.
- Esta unidad no se suministra con un dispositivo USB. Tiene que comprar un dispositivo USB disponible comercialmente.
- Tape la terminal de USB cuando no se esté utilizando.

Archivos de audio reproducibles

Formato de audio	Extensión
MP3	.mp3
WMA	.wma
AAC-LC	.m4a, .aac
PCM lineal (WAVE)	.wav
FLAC	.flac
Vorbis	.ogg

- Esta unidad puede mostrar etiquetas ID3 Versión 1.0/1.1/2.2/2.3/2.4 (para MP3).

NOTA

- Los formatos WMA y AAC que están cubiertos con DRM no pueden reproducirse.
- Aunque los archivos de audio cumplen los estándares anteriores, puede que no sea posible la reproducción según los tipos o condiciones del medio o dispositivo.

Archivos de vídeo aceptados

Formato de vídeo	Extensión
MPEG-1	.mpg, .mpeg
MPEG-2	.mpg, .mpeg
MPEG-4	.mp4, .avi
H.264/MPEG-4 AVC	.mp4, .mkv, .avi, .flv, .f4v, .ts
MKV	.mkv

Nota para especificaciones

Sección de Bluetooth

Frecuencia

: 2,402 – 2,480 GHz

Potencia de salida

: +8 dBm (AVE), clase de potencia 1

General

Impedancia del altavoz

: 4 – 8 Ω

Voltaje de funcionamiento

: batería de coche de 12 V CC

Derechos de autor

- La marca Bluetooth® y sus logotipos son marcas registradas propiedad de Bluetooth SIG, Inc., y cualquier uso de los mismos por JVC/KENWOOD Corporation se realiza bajo licencia. El resto de marcas comerciales y nombres comerciales corresponden a sus respectivos propietarios.
- Use of the Made for Apple badge means that an accessory has been designed to connect specifically to the Apple product(s) identified in the badge and has been certified by the developer to meet Apple performance standards. Apple is not responsible for the operation of this device or its compliance with safety and regulatory standards. Please note that the use of this accessory with an Apple product may affect wireless performance.
- Apple, iPhone, iPod, iPod touch, and Lightning are trademarks of Apple Inc., registered in the U.S. and other countries.
- Microsoft and Windows Media are either registered trademarks or trademarks of Microsoft Corporation in the United States and/or other countries.
- THIS PRODUCT IS LICENSED UNDER THE MPEG-4 VISUAL PATENT PORTFOLIO LICENSE FOR THE PERSONAL AND NON-COMMERCIAL USE OF A CONSUMER FOR (i) ENCODING VIDEO IN COMPLIANCE WITH THE MPEG-4 VISUAL STANDARD ("MPEG-4 VIDEO") AND/OR (ii) DECODING MPEG-4 VIDEO THAT WAS ENCODED BY A CONSUMER ENGAGED IN A PERSONAL AND NON-COMMERCIAL ACTIVITY AND/OR WAS OBTAINED FROM A VIDEO PROVIDER LICENSED BY MPEG LA TO PROVIDE MPEG-4 VIDEO. NO LICENSE IS GRANTED OR SHALL BE IMPLIED FOR ANY OTHER USE. ADDITIONAL INFORMATION INCLUDING THAT RELATING TO PROMOTIONAL, INTERNAL AND COMMERCIAL USES AND LICENSING MAY BE OBTAINED FROM MPEG LA, LLC. SEE [HTTP://WWW.MPEGLA.COM](http://www.MPEGLA.COM).
- THIS PRODUCT IS LICENSED UNDER THE AVC PATENT PORTFOLIO LICENSE FOR THE PERSONAL USE OF A CONSUMER OR OTHER USES IN WHICH IT DOES NOT RECEIVE REMUNERATION TO (i) ENCODE VIDEO IN COMPLIANCE WITH THE AVC STANDARD ("AVC VIDEO")

Acerca de esta unidad

AND/OR (j) DECODE AVC VIDEO THAT WAS ENCODED BY A CONSUMER ENGAGED IN A PERSONAL ACTIVITY AND/OR WAS OBTAINED FROM A VIDEO PROVIDER LICENSED TO PROVIDE AVC VIDEO. NO LICENSE IS GRANTED OR SHALL BE IMPLIED FOR ANY OTHER USE. ADDITIONAL INFORMATION MAY BE OBTAINED FROM MPEG LA, L.L.C. SEE [HTTP://WWW.MPEGLA.COM](http://www.mpegla.com)

- libFLAC

Copyright (C) 2000-2009 Josh Coalson

Copyright (C) 2011-2013 Xiph.Org Foundation

- Redistribution and use in source and binary forms, with or without modification, are permitted provided that the following conditions are met:
- Redistributions of source code must retain the above copyright notice, this list of conditions and the following disclaimer.
- Redistributions in binary form must reproduce the above copyright notice, this list of conditions and the following disclaimer in the documentation and/or other materials provided with the distribution.

Neither the name of the Xiph.org Foundation nor the names of its contributors may be used to endorse or promote products derived from this software without specific prior written permission.

THIS SOFTWARE IS PROVIDED BY THE COPYRIGHT HOLDERS AND CONTRIBUTORS "AS IS" AND ANY EXPRESS OR IMPLIED WARRANTIES, INCLUDING, BUT NOT LIMITED TO, THE IMPLIED WARRANTIES OF MERCHANTABILITY AND FITNESS FOR A PARTICULAR PURPOSE ARE DISCLAIMED. IN NO EVENT SHALL THE FOUNDATION OR CONTRIBUTORS BE LIABLE FOR ANY DIRECT, INDIRECT, INCIDENTAL, SPECIAL, EXEMPLARY, OR CONSEQUENTIAL DAMAGES (INCLUDING, BUT NOT LIMITED TO, PROCUREMENT OF SUBSTITUTE GOODS OR SERVICES; LOSS OF USE, DATA, OR PROFITS; OR BUSINESS INTERRUPTION) HOWEVER CAUSED AND ON ANY THEORY OF LIABILITY, WHETHER IN CONTRACT, STRICT LIABILITY, OR TORT (INCLUDING NEGLIGENCE OR OTHERWISE) ARISING IN ANY WAY OUT OF THE USE OF THIS SOFTWARE, EVEN IF ADVISED OF THE POSSIBILITY OF SUCH DAMAGE.

- libogg

Copyright (c) 2002, Xiph.org Foundation Redistribution and use in source and binary forms, with or without modification, are permitted provided that the following conditions are met:

- Redistributions of source code must retain the above copyright notice, this list of conditions and the following disclaimer.
- Redistributions in binary form must reproduce the above copyright notice, this list of conditions and the following disclaimer in the documentation and/or other materials provided with the distribution.
- Neither the name of the Xiph.org Foundation nor the names of its contributors may be used to endorse or promote products derived from this software without specific prior written permission.

THIS SOFTWARE IS PROVIDED BY THE COPYRIGHT HOLDERS AND CONTRIBUTORS "AS IS" AND ANY EXPRESS OR IMPLIED WARRANTIES, INCLUDING, BUT NOT LIMITED TO, THE IMPLIED WARRANTIES OF MERCHANTABILITY AND FITNESS FOR A PARTICULAR PURPOSE ARE DISCLAIMED. IN NO EVENT SHALL THE FOUNDATION OR CONTRIBUTORS BE LIABLE FOR ANY DIRECT, INDIRECT, INCIDENTAL, SPECIAL, EXEMPLARY, OR CONSEQUENTIAL DAMAGES (INCLUDING, BUT NOT LIMITED TO, PROCUREMENT OF SUBSTITUTE GOODS OR SERVICES; LOSS OF USE, DATA, OR PROFITS; OR BUSINESS INTERRUPTION) HOWEVER CAUSED AND ON ANY THEORY OF LIABILITY, WHETHER IN CONTRACT, STRICT LIABILITY, OR TORT (INCLUDING NEGLIGENCE OR OTHERWISE) ARISING IN ANY WAY OUT OF THE USE OF THIS SOFTWARE, EVEN IF ADVISED OF THE POSSIBILITY OF SUCH DAMAGE.

■ Información acerca de la eliminación de equipos eléctricos, electrónicos y baterías al final de la vida útil (aplicable a los países de la Unión Europea que hayan adoptado sistemas independientes de recogida de residuos)

Los productos y las pilas con el símbolo (cubo de basura tachado) no podrán ser desechados como residuos domésticos.

Los equipos eléctricos, electrónicos y baterías al final de la vida útil, deberán ser reciclados en instalaciones que puedan dar el tratamiento adecuado a estos productos y a sus subproductos residuales correspondientes.

Póngase en contacto con su administración local para obtener información sobre el punto de recogida más cercano.

Un tratamiento correcto del reciclaje y la eliminación de residuos ayuda a conservar los recursos y evita al mismo tiempo efectos perjudiciales en la salud y el medio ambiente.

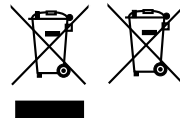

Índice

Antes de utilizar.....	98
Como ler este manual.....	98
Precauções.....	98
Primeiros Passos.....	99
Definições do Relógio.....	99
Básicos.....	100
Funções dos botões no painel frontal.....	100
Operações comuns.....	100
Ecrã de INÍCIO.....	100
Ecrã de controlo da fonte.....	100
Rádio Digital.....	101
Operação Básica do Rádio Digital.....	101
Configuração do Rádio Digital.....	101
Sintonizador.....	102
Operação Básica do Sintonizador.....	102
Configuração de Sintonizador.....	102
USB.....	103
Preparativos.....	103
Operações de reprodução.....	103
iPod/iPhone.....	104
Preparativos.....	104
Operações de reprodução.....	104
Componentes Externos.....	105
Utilizar leitores de áudio/vídeo externos.....	105
Câmara de vista traseira.....	105
Controlar o Áudio.....	105
Controlar o áudio geral.....	105
Bluetooth.....	106
Registe o seu smartphone na unidade.....	106
Receber uma chamada.....	106
Fazer uma chamada.....	106
Reproduzir um dispositivo de áudio Bluetooth.....	107
Instalação.....	107
Antes da instalação.....	107
Instalar a unidade.....	108
Sobre esta unidade.....	112
Mais informação.....	112
Nota para especificações.....	112
Direitos de autor.....	112

- Para operações e informações detalhadas, consulte o MANUAL DE INSTRUÇÕES no seguinte website:

<<https://www.jvc.net/cs/car/>>



Como ler este manual

- Os painéis mostrados neste manual são exemplos utilizados para dar explicações claras sobre as operações. Por esta razão, poderão ser diferentes dos painéis reais.
- Nos procedimentos de operação, os parênteses indicam a tecla ou o botão que deve pressionar.
 - < >: indica o nome de botões de painel.
 - []: indica o nome de teclas de toque

Antes de utilizar

Precauções

▲ ADVERTÊNCIA

■ Para evitar lesões ou um incêndio, tome as seguintes precauções:

- Para evitar um curto-circuito, nunca coloque ou deixe objetos metálicos (como moedas ou ferramentas) dentro da unidade.
- Não veja nem fixe os olhos no visor da unidade quando está a conduzir por longos períodos.
- Se aparecerem problemas durante a instalação, consulte o seu revendedor JVC.

■ Precauções de utilização desta unidade

- Quando comprar acessórios opcionais, confirme junto do representante JVC que eles funcionam com o seu modelo e na sua zona.
- A função Radio Data System (Sistema dados rádio) ou Radio Broadcast não funciona onde o serviço não é suportado por nenhuma estação de difusão.

■ Proteger o monitor

- Para proteger o monitor de danos, não opere o monitor utilizando uma esferegáfica ou um objeto semelhante com ponta afiada.

■ Limpar a unidade

Se o painel frontal da unidade estiver manchado, limpe-o com um pano macio e seco como um pano de silicone. Se a painel frontal estiver muito manchado, limpe a mancha com um pano humedecido com detergente neutro e, de seguida, limpe-o com um pano seco.

▲ ATENÇÃO

- A aplicação direta de spray de limpeza na unidade poderá afetar as respetivas peças mecânicas. Limpar o painel frontal com um pano que não seja macio ou usando um líquido volátil, como diluente ou álcool, pode riscar a superfície ou apagar caracteres.

■ Como reiniciar a unidade

Se a unidade ou a unidade ligada não funcionar corretamente, reinicialize-a.

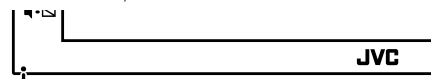

Botão de reposição



Este símbolo no produto indica instruções de operação e manutenção importantes neste manual.
Certifique-se de que lê atentamente as instruções neste manual.

Primeiros Passos

1 Rode a chave de ignição do seu carro para ACC.

A unidade está ligada.

2 Pressione o botão .

3 Toque em [].



4 Toque na tecla correspondente e defina o valor.

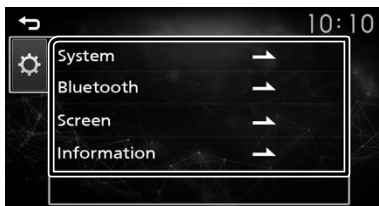

[System]

[Beep Tone]

Ativa ou desativa o tom de toque das teclas. "ON" (LIGADO) (Padrão), "OFF" (DESLIGADO)

[Language]

Selecione o idioma utilizado para o ecrã de controlo e os itens de definição. A predefinição é "English" (Inglês).

[Time/Date]

Ajuste a hora do relógio. (P.99)

[Clock Mode]

Selecione o formato de apresentação da hora. [12hr] / [24hr] (Padrão)

[Parking Guidelines]

É possível visualizar as orientações de estacionamento para facilitar o estacionamento quando for engatada a marcha-atrás (R). A predefinição é "ON".

[Guidelines SETUP]

Se seleccionar [ON] para [Parking Guidelines], pode ajustar as orientações de estacionamento.

[System Reset]

Toque em [System Reset] e, em seguida, toque em [YES] para definir todas as definições para as predefinições iniciais.

[Bluetooth]

Apresenta o ecrã de Definições do Bluetooth.

[Screen]

[Dimmer]

Selecione o modo de gradação. "High" (Padrão) / "Mid" / "Low"

[Demo]

Selecione o modo de demonstração. A predefinição é "ON".

[Information]

Exibe a versão do software desta unidade.

5 Toque em [].

Definições do Relógio

■ Sincronização da hora do relógio com o FM RDS

Ative [RDS Clock Sync] (Sincronização do Relógio RDS).

Consulte a secção **Configuração de Sintonizador (P.102)**.

■ Ajustar o relógio manualmente

 NOTA

• Desative [RDS Clock Sync] antes de acertar o relógio.

1 Pressione o botão .

2 Toque em [].

3 Toque em [System].

4 Toque em [Time/Date].

É apresentado o ecrã Relógio.

5 Toque em [▲] ou [▼] para acertar a hora do relógio.



6 Toque em [].

Básicos

Funções dos botões no painel frontal

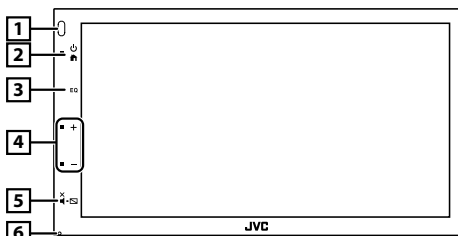

1 Sensor Remoto

- Recebe o sinal do controlo remoto.

2 (INÍCIO)

- Apresenta o ecrã HOME. **(P.100)**
- Se pressionado durante 1 segundo, desliga a alimentação.
- Quando a alimentação está desligada, liga a alimentação.

3 EQ

- Apresenta o ecrã de Áudio.* **(P.105)**
- * O ecrã de Áudio não é exibido no ecrã CONFIGURAÇÃO ou no ecrã da lista, etc.

4 +, - (Volume)

- Ajusta o volume. O volume vai até ao nível 20 quando premir [+] continuamente.

5 (SILENCIAR, Ecrã desligado)

- Silencia/restaura o som.
- Se premido durante 1 segundo, desliga o ecrã. Quando o ecrã estiver desligado, toque no visor para ligar o ecrã.

6 Repor

- Se a unidade ou a unidade ligada não funcionar corretamente, esta repõe as definições iniciais quando este botão é pressionado.

Operações comuns

Ligar a alimentação

1 Pressione o botão .



Desligar a alimentação

1 Pressione e segure o botão .

Ecrã de INÍCIO

1 Pressione o botão .

Aparece o ecrã HOME (inicial).



1 Mostrador de Relógio

2 Muda para a emissão de rádio. **(P.102)**

3 [USB]

Reproduz ficheiros num dispositivo USB. **(P.103)**

[iPod]

Reproduz um iPod/iPhone. **(P.104)**

- Quando está conectado um iPod/iPhone.

[Mirroring]

Exibe o ecrã de Espelhamento.

- Quando estiver conectado um dispositivo Android com a aplicação "Mirroring OB for JVC" instalada.

4 Muda para um componente externo conectado ao terminal de entrada AV-IN. **(P.105)**

5 Mostra o ecrã Mãos Livres. **(P.106)**

6 Reproduz um leitor de áudio Bluetooth. **(P.107)**

7 Muda para a transmissão de rádio digital. **(P.101)**

8 Apresenta o ecrã CONFIGURAÇÃO. **(P.99)**

Ecrã de controlo da fonte



1 : Volta para o ecrã original.

: Apresenta o ecrã de Áudio. **(P.105)**

Rádio Digital

Operação Básica do Rádio Digital

- 1 Pressione o botão <🏠>.
- 2 Toque em [Digital Radio].

📺 Ecrã de controlo da fonte



- 1 Mostra a informação sobre o serviço atual:
Nome do serviço, Nome do conjunto, Género de PTY, Canal
- 2 **[DAB]**: Muda a banda predefinida do Rádio Digital.
"DAB1", "DAB2", "DAB3"
[DLS]: Exibe o ecrã de Segmento de Etiqueta Dinâmica
[◀▶]: Seleccione um conjunto, serviço e componente.
[☰]: Apresenta o ecrã de Configuração do Rádio Digital. **(P.101)**
- 3 Chama o serviço memorizado.
Se tocar na tecla durante 2 segundos, guarda na memória o serviço atual a ser recebido no momento.

📺 Memorize um serviço

Pode guardar na memória o serviço atual a ser recebido.

- 1 Sintonize num serviço que queira predefinir.
 - 2 Toque e mantenha pressionado [#] (#:1-5) em que pretende armazenar o serviço.
- 📺 Seleccione um serviço memorizado
- 1 Toque em [#] (#:1-5).

Configuração do Rádio Digital

- 1 Toque em [☰].
- 2 Defina cada item da seguinte forma.



[Service List]

Apresenta o ecrã de Lista de Serviço.

- [🏠]: Toque e depois toque em [Yes] para encontrar a lista de serviços mais recente.

[TI]

Muda automaticamente para a informação de trânsito quando começa o boletim de trânsito.
"ON" (LIGADO), "OFF" (DESLIGADO) (Padrão)

[PTY]

Procura um programa por tipo.

[Priority]

Se o mesmo serviço for fornecido pelo sistema de dados de rádio quando a receção do serviço fornecida pelo rádio digital se tornar deficiente, muda automaticamente para o sistema de dados de rádio.

"ON" (LIGADO), "OFF" (DESLIGADO) (Padrão)

[Announcement Select]

Muda para o serviço de declaração definido.

[Related Service]

Quando seleciona ON (Ligar), a unidade comuta para um serviço relacionado (se existir) quando a rede do serviço DAB não está disponível. A predefinição é "OFF".

[Antenna Power]

Define a alimentação da antena do rádio digital. Definido em "ON" quando a antena do rádio digital em utilização está equipada com um amplificador. A predefinição é "ON".

- 3 Toque em [↩].

Sintonizador

Operação Básica do Sintonizador

- 1 Pressione o botão .
- 2 Toque em [Tuner].

Ecrã de controlo da fonte

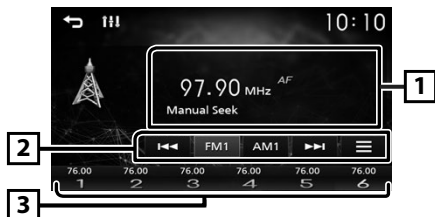

1 Mostra a informação sobre a estação atual: Nome PS, Frequência, Género PTY, Itens de Indicador

2 **[FM]** : Muda a banda FM.
"FM1", "FM2", "FM3"

[AM] : Muda a banda AM.
"AM1", "AM2"

[]: Sintoniza automaticamente uma estação com boa receção.

[] : Apresenta o ecrã CONFIGURAÇÃO de Sintonizador. **(P.102)**

3 Chama a estação memorizada.
Se tocar na tecla durante 2 segundos, guarda na memória a estação atual a ser recebida no momento.

Memória automática

Pode predefinir 6 estações para a banda atual (FM1/FM2/FM3/AM1/AM2).

1 Toque em **[FM]** ou **[AM]** para selecionar a banda.

2 Toque em [].

3 Toque em **[Auto Store]**.

As estações locais com sinais mais fortes são automaticamente encontradas e armazenadas.

Memória manual

Pode armazenar na memória a estação a ser recebida no momento.

1 Sintonize numa estação que queira predefinir.

2 Toque e mantenha pressionado [#] (#:1-6) em que pretende armazenar a estação.

Recuperar a estação predefinida

1 Toque em [#] (#:1-6).

Configuração de Sintonizador

1 Toque em [].

2 Defina cada item da seguinte forma.

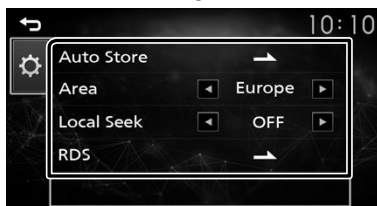

[Auto Store]

Procura e guarda automaticamente as 6 estações com o sinal mais forte para a banda selecionada.
"Auto Store" aparece.

[Local Seek]

Sintoniza apenas nas estações com força de sinal suficiente. (O indicador **LOC** acende-se.)
"ON" (LIGADO), "OFF" (DESLIGADO) (Padrão)

[RDS] *1

Apresenta o ecrã de Definições RDS.

[AF]

Quando a receção de uma estação é deficiente, muda automaticamente para a estação que está a transmitir o mesmo programa, na mesma rede Radio Data System (RDS).

"ON" (LIGADO) (Padrão), "OFF" (DESLIGADO)

[TA]

Muda automaticamente para a informação de trânsito quando começa o boletim de trânsito. (O indicador **TI** acende-se.)

"ON" (LIGADO), "OFF" (DESLIGADO) (Padrão)

[RDS Clock Sync]

Sincronizar a hora da estação do Sistema de Dados de Rádio e o relógio desta unidade.

"ON" (LIGADO) (Padrão), "OFF" (DESLIGADO)

[PTY]

Selecione um tipo de programa.

[PTY Seek]

Procura um programa por tipo.

*1 Apenas FM

3 Toque em [].

USB

Preparativos

■ Conectar a um dispositivo USB

- 1 Remova a tampa do terminal USB.
- 2 Ligue o dispositivo USB com o cabo USB.

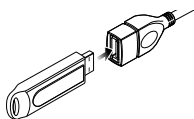

A unidade lê o dispositivo e inicia a reprodução.

■ Para desligar o dispositivo USB:

- 1 Pressione o botão <🏠>.
- 2 Toque numa fonte diferente de [USB].
- 3 Desligue o dispositivo USB.

■ Compatibilidade com dispositivos USB

Esta unidade consegue reproduzir ficheiros MPEG1/ MPEG2/ MPEG4/ H.264/ MKV/ MP3/ WMA/ AAC/ WAV/ FLAC/ OGG armazenados num dispositivo USB de armazenamento em massa.

Operações de reprodução

■ Controle a música que está a ouvir no ecrã de controlo das fontes.



- 1 A capa do ficheiro a tocar é exibida.
- 2 Mostra a informação sobre o ficheiro atual.
- 3 Tempo de reprodução/Número de ficheiro
Barra de tempo de reprodução : Para confirmação da posição de reprodução atual.

4 [🎲] : Selecciona o modo de Reprodução aleatória.

[🔄] : Selecciona o modo de Reprodução em repetição.

[▶], [⏸] : Reproduz ou pausa.

[⏮], [⏭] : Procura o conteúdo anterior/ seguinte.

Toque sem soltar para avançar rapidamente ou retroceder rapidamente.

[🔍] : Procura o ficheiro. (P.103)

■ Para reprodução de Vídeo

- 1 Quando os botões de operação não forem exibidos no ecrã, toque no ecrã.

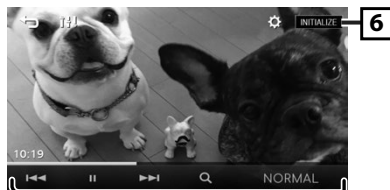

6 [⚙️] : Pode ajustar a qualidade da imagem no ecrã do vídeo.

[INITIALIZE] : Para limpar o ajuste.

7 [▶], [⏸] : Reproduz ou pausa.

[⏮], [⏭] : Procura o conteúdo anterior/ seguinte.

Toque sem soltar para avançar rapidamente ou retroceder rapidamente.

[🔍] : Procura o ficheiro. (P.103)

[NORMAL]/[16:9]/[4:3] : Selecciona um modo de ecrã.

■ Seleccionar uma faixa numa lista (Procurar o ficheiro)

- 1 Toque em [🔍].
- 2 Selecciona se quer procurar ficheiros de áudio [🎵] ou ficheiros de vídeo [🎬].
- 3 Toque em [📁] para se deslocar para a hierarquia superior.
- 4 Toque na pasta pretendida.

Quando toca numa pasta os seus conteúdos são apresentados.

- Toque em [📁] para se deslocar para a hierarquia superior.

5 Toque no item pretendido da lista de conteúdos.

Inicia-se a reprodução.

📌 NOTA

- O ecrã de controlo da fonte aparece quando toca em [📁], na hierarquia superior.

iPod/iPhone

Preparativos

■ Conectar a iPod/iPhone

- Para modelos com conector Lightning: Use o cabo USB Áudio para iPod/iPhone—KS-U62 (acessório opcional).
- Para detalhes sobre conectar a iPod/iPhone, consulte a página 111.

1 Remova a tampa do terminal USB.

2 Ligue o iPod / iPhone.

A unidade lê o dispositivo e inicia a reprodução.

■ Para desconectar o iPod/iPhone

1 Pressione o botão .

2 Toque numa fonte diferente de [iPod].

3 Desligue o cabo do iPod/iPhone.

■ Compatibilidade iPod/iPhone

Os seguintes modelos podem ser ligados a esta unidade.

Feito para

- | | | |
|------------------------------|---------------------|------------------|
| • iPhone 12 Pro Max | • iPhone 11 Pro Max | • iPhone 8 Plus |
| • iPhone 12 Pro | • iPhone 11 Pro | • iPhone 8 |
| • iPhone 12 | • iPhone 11 | • iPhone 7 Plus |
| • iPhone 12 mini | • iPhone XS Max | • iPhone 7 |
| • iPhone SE (2nd generation) | • iPhone XS | • iPhone SE |
| | • iPhone XR | • iPhone 6s Plus |
| | • iPhone X | • iPhone 6s |
| | | • iPhone 6 Plus |

✎ NOTA

- Se iniciar a reprodução depois de ligar o iPod, a música que estava a ser reproduzida pelo iPod é reproduzida primeiro.
- Coloque a tampa no terminal USB quando não o estiver a utilizar.

Operações de reprodução

■ Controle a música que está a ouvir no ecrã de controlo das fontes.



1 Capa (Mostrado se a faixa tiver capa de álbum)



2 Mostra a informação sobre o ficheiro atual.

3 Tempo de reprodução/Número de ficheiro
Barra de tempo de reprodução : Para confirmação da posição de reprodução atual.

4 [] : Seleciona o modo de Reprodução aleatória.

[] : Seleciona o modo de Reprodução em repetição.

[], [] : Reproduz ou pausa.

[], [] : Procura o conteúdo anterior/ seguinte.
Toque sem soltar para avançar rapidamente ou retroceder rapidamente.

[] : Procura o conteúdo. (P.104)

■ Selecionar conteúdos numa lista

1 Toque em [].

2 Toque no item pretendido.

Quando toca numa categoria, os seus conteúdos são apresentados.

3 Toque no item pretendido da lista de conteúdos.

Inicia-se a reprodução.

- Toque em [] para se deslocar para a hierarquia superior.

✎ NOTA

- O ecrã de controlo da fonte aparece quando toca em [], na hierarquia superior.

Componentes Externos **Controlar o Áudio**

Utilizar leitores de áudio/vídeo externos

■ Iniciar a reprodução

- 1 Conecte um componente externo ao terminal de entrada AV-IN. (P.110)
- 2 Pressione o botão <🏠>.
- 3 Toque em [AV-IN].
- 4 Ligue o componente ligado e inicie a reprodução da fonte do som.

■ Para reprodução de Vídeo

- 1 Quando os botões de operação não forem exibidos no ecrã, toque no ecrã.

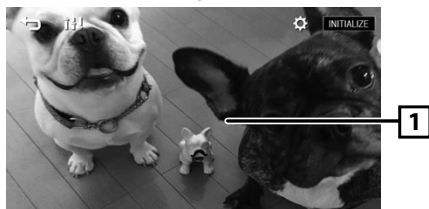

Câmara de vista traseira

Para usar uma câmara de vista traseira, é necessária a conexão de guia REVERSE. Para conectar uma câmara de vista traseira. (P.110)

■ Apresentar a imagem a partir da câmara de vista traseira

O ecrã de vista traseira é exibido quando for engatada a marcha-atrás (R).



- Para apagar a mensagem de precaução, toque no ecrã.

Pode ajustar várias definições, como o balanço áudio ou o nível de subwoofer.

- 1 Pressione o botão <EQ>.
- 2 Consulte o seguinte para cada método de operação.

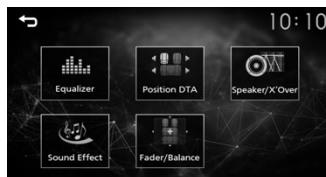

Controlar o áudio geral

- 1 Pressione o botão <EQ>.
- 2 Toque em [Fader / Balance].
- 3 Defina cada item da seguinte forma.



[Fader Balance]

Balance	Ajuste o equilíbrio do volume à esquerda e à direita.
[▶][◀]	15 (direita) a 15 (esquerda)
Fader	Ajuste o equilíbrio do volume à frente e atrás.
[▲][▼]	15 (frente) a 15 (trás)
[INITIALIZE]	Para limpar o ajuste.

Bluetooth

Registe o seu smartphone na unidade

Pode utilizar o seu smartphone com Bluetooth quando estiver emparelhado com esta unidade.

1 Ligue a função Bluetooth no seu smartphone/telemóvel.

2 Procure a unidade ("KW-M27DBT") a partir do seu smartphone/telemóvel.

Se for necessário um código PIN, introduza o código PIN ("0000").

-  aparece quando o Bluetooth do smartphone está conectado.

Desligar o dispositivo

- Desligue a função Bluetooth no seu smartphone/telemóvel.
- Desligue a ignição.

Receber uma chamada

1 Toque em .

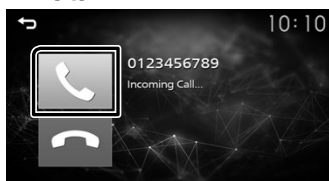

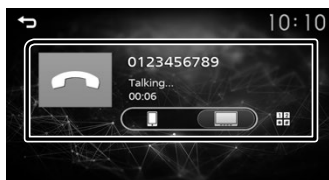

- : Rejeite uma chamada recebida.

Operações durante uma chamada



 Terminar uma chamada

 Pode enviar tonalidades, tocando nas teclas correspondentes no ecrã.

- Toque em  para fechar a janela.

 Alterna a saída de voz entre o smartphone/telemóvel e o altifalante.

• **Ajustar o volume do recetor**

Pressione o botão < + > ou < - >.

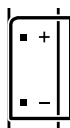

Fazer uma chamada



1 Pressione o botão .

2 Toque em [Phone].

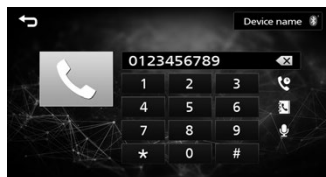



3 Consulte a seguinte tabela para cada método de operação.





Ligar introduzindo um número de telefone

- 1) Introduza um número de telefone, utilizando as teclas numéricas.
- 2) Toque em .
Faça uma chamada
- Toque em  para eliminar a última entrada.

Ligar utilizando registos de chamadas

- 1) Toque em .
- 2) Toque em  (Chamadas Recebidas),  (Chamadas Efetuadas),  (Chamadas Perdidas).
- 3) Selecionar o número de telefone a partir da lista.
Faça uma chamada

Ligar utilizando a lista telefónica

- 1) Toque em .
- 2) Selecione o nome a partir da lista.
Faça uma chamada
- : Atualiza a lista telefónica. Toque neste botão depois de ter feito uma alteração na lista telefónica do seu smartphone/telemóvel.

Bluetooth

Reproduzir um dispositivo de áudio Bluetooth

1 Pressione o botão .

2 Toque em [BT Audio].

Ecrã de controlo da fonte





1 Mostra a informação sobre o ficheiro atual.

2 Tempo de reprodução/Número de ficheiro
Barra de tempo de reprodução : Para confirmação da posição de reprodução atual.

3  : Seleciona o modo de Reprodução aleatória.

 : Seleciona o modo de Reprodução em repetição.

 ,  : Reproduz ou pausa.

 ,  : Procura o conteúdo anterior/seguinte.
Toque sem soltar para avançar rapidamente ou retroceder rapidamente.

 : Procura o ficheiro. **(P.107)**

NOTA

- As indicações de operação e exibição podem diferir de acordo com sua disponibilidade no dispositivo conectado.

Selecionar conteúdos numa lista

1 Toque em [Q].

2 Toque no item pretendido.

Quando toca numa categoria, os seus conteúdos são apresentados.

3 Toque no item pretendido da lista de conteúdos.

Inicia-se a reprodução.

- Toque em  para se deslocar para a hierarquia superior.

NOTA

- O ecrã de controlo da fonte aparece quando toca em , na hierarquia superior.

Instalação

Antes da instalação

Antes da instalação desta unidade, tenha em consideração as seguintes precauções.

AVISOS

- Se ligar o fio de ignição (vermelho e o fio da bateria (amarelo) ao chassis do automóvel (terra), pode causar um curto-circuito, que por sua vez pode causar um incêndio. Ligue esses fios sempre à fonte de energia que passa através da caixa de fusíveis.
- Não elimine o fusível do cabo de ignição (vermelho) e do cabo da bateria (amarelo). A fonte de alimentação deve ser ligada aos cabos passando pelo fusível.

ATENÇÃO

- Instale este aparelho na consola do seu automóvel. Não toque nas peças de metal deste aparelho durante ou pouco depois da utilização do aparelho. As peças de metal, como por exemplo a armação, aquecem.

NOTA

- A instalação e ligação deste aparelho requerem conhecimentos e experiência. Para maior segurança, deixe as operações de montagem e ligação a cargo de profissionais.
- Assegure-se de que liga a unidade a uma fonte de alimentação de 12 V CC com massa negativa.
- Não instale o aparelho num local exposto à luz solar direta ou calor e humidade excessivos. Evite também locais com demasiada poeira ou a possibilidade de salpicos de água.
- Não utilize os seus próprios parafusos. Utilize apenas os parafusos fornecidos. O uso de parafusos não apropriados pode resultar em danos ao aparelho principal.
- Se a ignição do automóvel não tiver uma posição ACC, conecte os fios da ignição a uma fonte de energia que possa ser ativada e desativada pela chave de ignição. Se ligar o fio de ignição a uma fonte de alimentação com um débito de tensão permanente, como os cabos da bateria, a bateria poderá ficar descarregada.
- Se a consola tiver tampa, certifique-se que instala o aparelho de forma a que o painel frontal não bata na tampa ao abrir e ao fechar.
- Se o fusível fundir, certifique-se primeiro de que os fios não tocam uns nos outros para não causar um curto-circuito, e substitua o fusível antigo por outro com a mesma potência.
- Isolar os cabos não ligados com fita isolante ou outro material similar. Para evitar curtos-circuitos, não remova as capas dos finais dos cabos não conectados ou dos terminais.

Instalação

- Fixe os fios com grampos de cabos e envolva uma fita de vinil em torno dos fios que entrem em contacto com peças metálicas para proteger os fios e evitar curto-circuito.
- Ligue os cabos individuais do altifalante aos terminais correspondentes. A unidade poderá ficar danificada ou deixar de funcionar se partilhar os fios ⊖ ou os ligar à massa a qualquer peça metálica do carro.
- Quando houver somente dois altifalantes conectados ao sistema, ligue os conectores a ambos os terminais de saída frontais ou a ambos os terminais de saída traseiros (não misture terminais frontais com traseiros). Por exemplo, se ligar o conector ⊕ do altifalante esquerdo a um terminal de saída dianteiro, não ligue o conector ⊖ a um terminal de saída traseiro.
- Depois que a unidade tiver sido instalada, verifique se as lâmpadas de stop, os pisca-piscas, os limpadores de pára-brisa, etc. do automóvel estão funcionando corretamente.
- Monte o aparelho de forma a que o ângulo de montagem seja de 30° ou menos.
- Não faça muita pressão sobre a superfície do painel quando instalar a unidade no automóvel. Caso contrário poderão resultar marcas, danos ou avarias.
- A recepção poderá ser reduzida se existirem objetos metálicos próximos da antena Bluetooth.

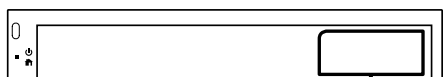

Unidade da antena Bluetooth

■ Acessórios fornecidos para instalação

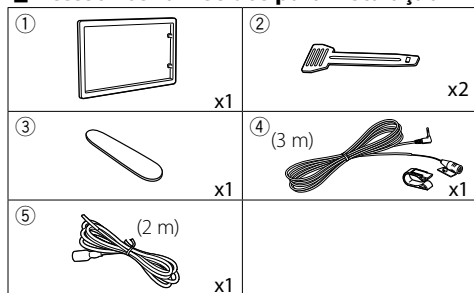

■ Método de instalação

- 1) Para prevenir um curto-circuito, remova a chave da ignição e desligue o terminal ⊖ da bateria.
- 2) Faça as ligações apropriadas dos cabos de entrada e saída de cada unidade.
- 3) Ligue o conector ISO à unidade.
- 4) Instale o aparelho no seu carro.
- 5) Volte a ligar o terminal ⊖ da bateria.
- 6) Pressione o botão de reposição.

Instalar a unidade

■ Carros não-japoneses

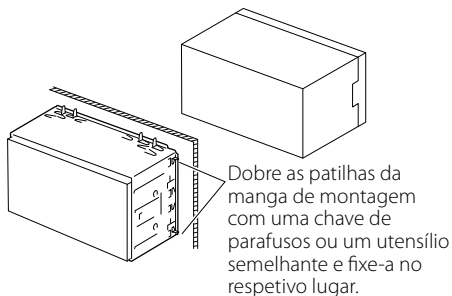

Dobre as patilhas da manga de montagem com uma chave de parafusos ou um utensílio semelhante e fixe-a no respetivo lugar.

✎ NOTA

- Certifique-se de que a unidade está firmemente instalada na posição adequada. Se a unidade estiver instável, poderá funcionar incorretamente (por exemplo, com falhas no som).

■ Moldura

- 1) Anexar acessório ① à unidade.

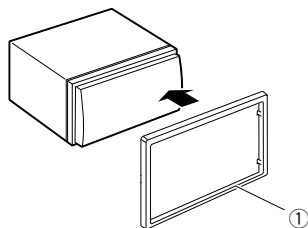

Instalação

■ Unidade do microfone

- 1) Verifique a posição de instalação do microfone (acessório ④).
- 2) Limpe a superfície de instalação.
- 3) Retire o separador do microfone (acessório ④) e coloque o microfone na placa apresentada abaixo.
- 4) Ligue o cabo do microfone na unidade, prendendo-o em várias posições com fita adesiva ou outro método.
- 5) Ajuste a direção do microfone (acessório ④) ao condutor.

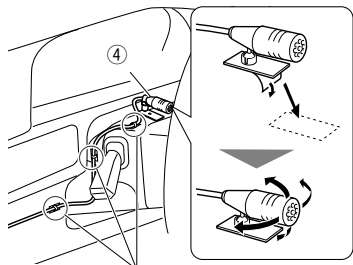

Fixe um cabo com fita adesiva.

📎 NOTA

- Se necessário, troque os cliques.



■ Retirar a moldura

- 1) Use a chave de extração (acessório ③) para levantar as quatro abas (duas na parte esquerda e duas na parte direita).

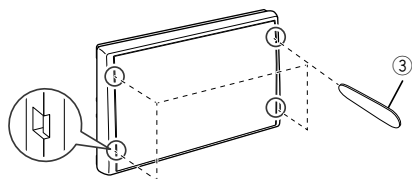

- 2) Puxe a moldura para a frente.

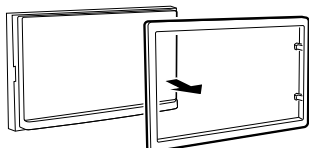

■ Retirar a unidade

- 1) Retire a moldura seguindo o passo 1 em "Retirar a moldura".
- 2) Insira a chave de extração (acessório ②) profundamente na ranhura, conforme mostrado. (A saliência na ponta da chave de extração deve estar virada para a unidade.)

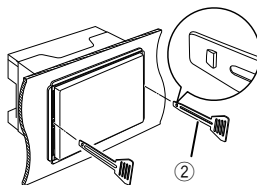

- 3) Com a chave de extração inserida segura, insira a outra chave de extração na ranhura.

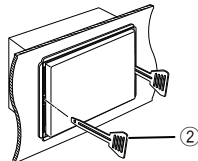

- 4) Puxe a unidade para fora até meio.

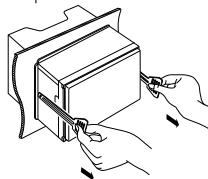

📎 NOTA

- Tenha cuidado para não se ferir com os pinos de retenção da chave de remoção.
- 5) Puxe a unidade totalmente para fora, com as mãos, tendo cuidado para não a deixar cair.

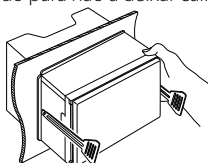

Instalação

■ Ligar os cabos aos terminais

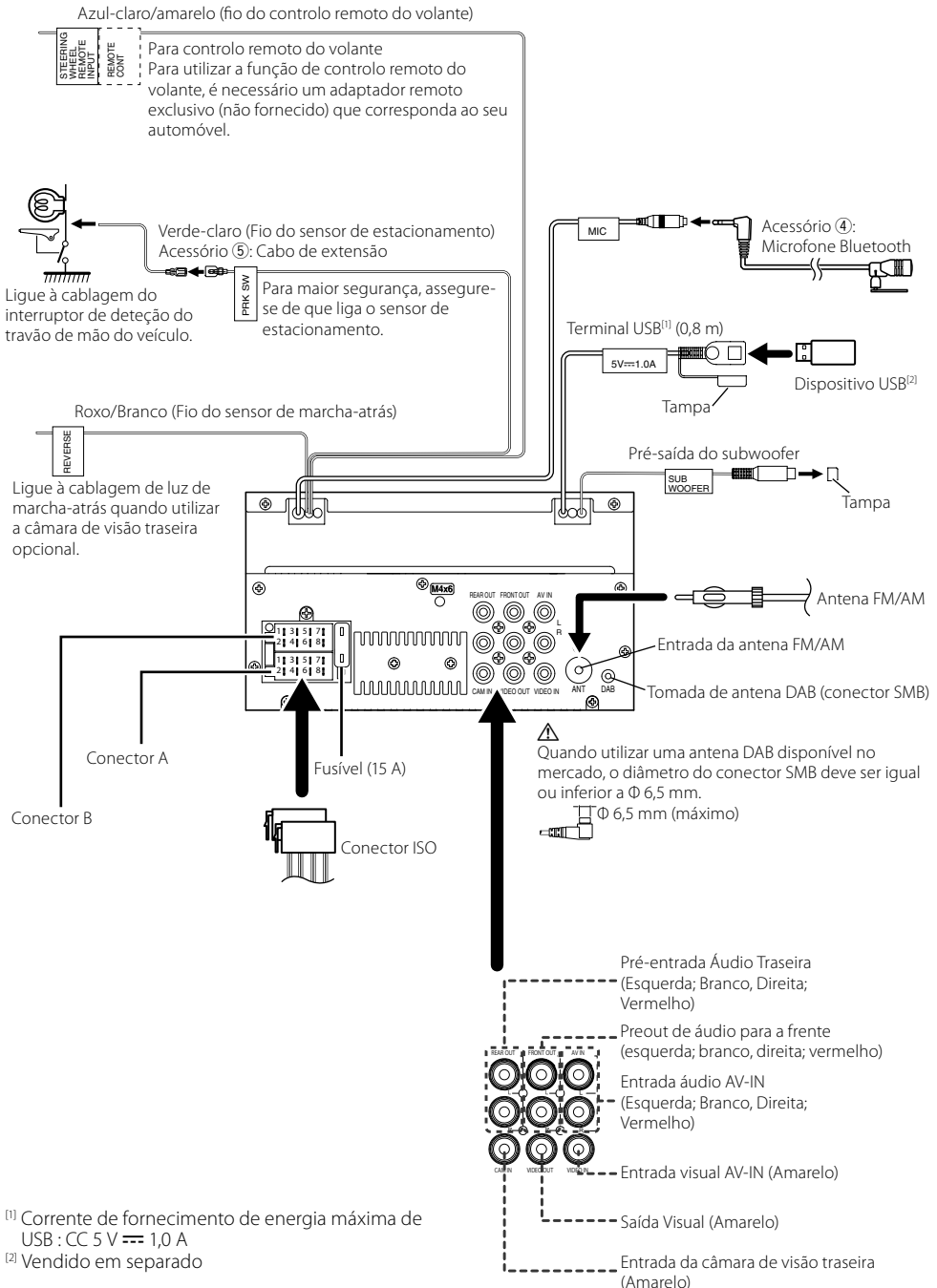

^[1] Corrente de fornecimento de energia máxima de USB : CC 5 V = 1,0 A

^[2] Vendido em separado

Instalação

■ Guia de funcionamento do conector da cablagem elétrica

Pino	Cor e função	
A-4	Amarelo	Bateria
A-5	Azul/Branco ^[1]	Controlo de energia
A-7	Vermelho	Ignição (ACC)
A-8	Preto	Ligação terra (massa)
B-1/ B-2	Roxo (+) / Roxo/Preto (-)	Traseiro direito
B-3/ B-4	Cinzento (+) / Cinzento/Preto (-)	Dianteiro direito
B-5/ B-6	Branco (+) / Branco/Preto (-)	Dianteiro esquerdo
B-7/ B-8	Verde (+) / Verde/Preto (-)	Traseiro esquerdo

^[1] Máx. 150 mA, 12 V

- Impedância do Altifalante: 4-8 Ω

⚠ ATENÇÃO

Antes de conectar os ISO comercialmente disponibilizados à unidade, verifique a seguinte condição:

- Certifique-se de que a atribuição de pino do conector corresponde à unidade JVC.
- Tenha precaução redobrada com o cabo de alimentação.
- Caso o cabo da pilha e o cabo de ignição não correspondam, altere-os adequadamente.
- Caso o carro não tenha um cabo de ignição, use uma interface disponível comercialmente.

■ Conectar um iPod/iPhone/Android

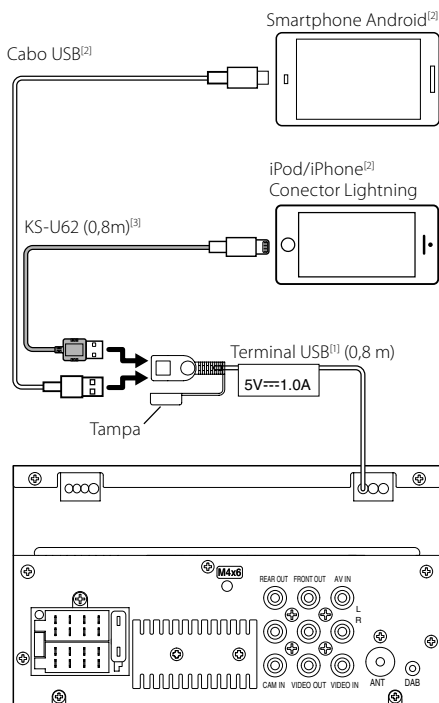

^[1] Corrente de fornecimento de energia máxima de USB : CC 5 V $\overline{=}$ 1,0 A

^[2] Vendido em separado

^[3] Acessório opcional

Sobre esta unidade

Mais informação

Compatibilidade com dispositivos USB

Esta unidade consegue reproduzir ficheiros MPEG1/ MPEG2/ MPEG4/ H.264/ MKV/ MP3/ WMA/ AAC/ WAV/ FLAC/ OGG armazenados num dispositivo USB de armazenamento em massa.

- Sistema de ficheiros: FAT16/ FAT32

NOTA

- Quando o dispositivo USB está ligado a esta unidade, pode ser carregado através do cabo USB.
- Instale o dispositivo USB num local em que não prejudique uma condução segura.
- Não é possível conectar um dispositivo USB através de um hub USB e Multi Card Reader.
- Faça cópias de segurança dos ficheiros áudio utilizado nesta unidade. Os ficheiros poderão ser apagados consoante as condições de funcionamento do dispositivo USB. Da nossa parte, não haverá lugar a qualquer compensação por danos decorrentes da perda dos dados armazenados.
- Não é fornecido nenhum dispositivo USB com a unidade. Deverá adquirir um dispositivo USB disponível no mercado.
- Coloque a tampa no terminal USB quando não o estiver a utilizar.

Ficheiros áudio reproduzíveis

Formato áudio	Extensão
MP3	.mp3
WMA	.wma
AAC-LC	.m4a, .aac
PCM linear (WAVE)	.wav
FLAC	.flac
Vorbis	.ogg

- Esta unidade pode mostrar a Versão 1.0/1.1/2.2/2.3/2.4 da Etiqueta ID3 (para MP3).

NOTA

- WMA e AAC abrangido por DRM, não pode ser reproduzido.
- Mesmo que os ficheiros áudio sejam compilados com as normas indicadas anteriormente, a reprodução pode ser impossível dependendo dos tipos ou condições dos suportes ou do dispositivo.

Ficheiros de vídeo aceitáveis

Formato de vídeo	Extensão
MPEG-1	.mpg, .mpeg
MPEG-2	.mpg, .mpeg
MPEG-4	.mp4, .avi
H.264/MPEG-4 AVC	.mp4, .mkv, .avi, .flv, .f4v, .ts
MKV	.mkv

Nota para especificações

Secção Bluetooth

Frequência

: 2,402 – 2,480 GHz

Alimentação de saída

: +8 dBm (AVE), Classe de potência 1

Geral

Impedância de altifalante

: 4 – 8 Ω

Tensão de operação

: bateria de automóvel de 12 V CC

Direitos de autor

- A palavra, marcas e logótipos Bluetooth® são marcas comerciais registadas de propriedade da Bluetooth SIG, Inc. e qualquer utilização de tais marcas pela JVCKENWOOD Corporation está sob licença. Outras marcas registadas e nomes de marcas são dos respetivos proprietários.
- Use of the Made for Apple badge means that an accessory has been designed to connect specifically to the Apple product(s) identified in the badge and has been certified by the developer to meet Apple performance standards. Apple is not responsible for the operation of this device or its compliance with safety and regulatory standards. Please note that the use of this accessory with an Apple product may affect wireless performance.
- Apple, iPhone, iPod, iPod touch, and Lightning are trademarks of Apple Inc., registered in the U.S. and other countries.
- Microsoft and Windows Media are either registered trademarks or trademarks of Microsoft Corporation in the United States and/or other countries.
- THIS PRODUCT IS LICENSED UNDER THE MPEG-4 VISUAL PATENT PORTFOLIO LICENSE FOR THE PERSONAL AND NON-COMMERCIAL USE OF A CONSUMER FOR (i) ENCODING VIDEO IN COMPLIANCE WITH THE MPEG-4 VISUAL STANDARD ("MPEG-4 VIDEO") AND/OR (ii) DECODING MPEG-4 VIDEO THAT WAS ENCODED BY A CONSUMER ENGAGED IN A PERSONAL AND NON-COMMERCIAL ACTIVITY AND/OR WAS OBTAINED FROM A VIDEO PROVIDER LICENSED BY MPEG LA TO PROVIDE MPEG-4 VIDEO. NO LICENSE IS GRANTED OR SHALL BE IMPLIED FOR ANY OTHER USE. ADDITIONAL INFORMATION INCLUDING THAT RELATING TO PROMOTIONAL, INTERNAL AND COMMERCIAL USES AND LICENSING MAY BE OBTAINED FROM MPEG LA, LLC. SEE [HTTP://WWW.MPEGLA.COM](http://www.mpegla.com).
- THIS PRODUCT IS LICENSED UNDER THE AVC PATENT PORTFOLIO LICENSE FOR THE PERSONAL USE OF A CONSUMER OR OTHER USES IN WHICH IT DOES NOT RECEIVE REMUNERATION TO (i) ENCODE VIDEO IN COMPLIANCE WITH THE AVC STANDARD ("AVC VIDEO")

Sobre esta unidade

AND/OR (j) DECODE AVC VIDEO THAT WAS ENCODED BY A CONSUMER ENGAGED IN A PERSONAL ACTIVITY AND/OR WAS OBTAINED FROM A VIDEO PROVIDER LICENSED TO PROVIDE AVC VIDEO. NO LICENSE IS GRANTED OR SHALL BE IMPLIED FOR ANY OTHER USE. ADDITIONAL INFORMATION MAY BE OBTAINED FROM MPEG LA, L.L.C. SEE [HTTP://WWW.MPEGLA.COM](http://www.mpegla.com)

- libFLAC

Copyright (C) 2000-2009 Josh Coalson

Copyright (C) 2011-2013 Xiph.Org Foundation

– Redistribution and use in source and binary forms, with or without modification, are permitted provided that the following conditions are met:

– Redistributions of source code must retain the above copyright notice, this list of conditions and the following disclaimer.

– Redistributions in binary form must reproduce the above copyright notice, this list of conditions and the following disclaimer in the documentation and/or other materials provided with the distribution.

Neither the name of the Xiph.org Foundation nor the names of its contributors may be used to endorse or promote products derived from this software without specific prior written permission.

THIS SOFTWARE IS PROVIDED BY THE COPYRIGHT HOLDERS AND CONTRIBUTORS "AS IS" AND ANY EXPRESS OR IMPLIED WARRANTIES, INCLUDING, BUT NOT LIMITED TO, THE IMPLIED WARRANTIES OF MERCHANTABILITY AND FITNESS FOR A PARTICULAR PURPOSE ARE DISCLAIMED. IN NO EVENT SHALL THE FOUNDATION OR CONTRIBUTORS BE LIABLE FOR ANY DIRECT, INDIRECT, INCIDENTAL, SPECIAL, EXEMPLARY, OR CONSEQUENTIAL DAMAGES (INCLUDING, BUT NOT LIMITED TO, PROCUREMENT OF SUBSTITUTE GOODS OR SERVICES; LOSS OF USE, DATA, OR PROFITS; OR BUSINESS INTERRUPTION) HOWEVER CAUSED AND ON ANY THEORY OF LIABILITY, WHETHER IN CONTRACT, STRICT LIABILITY, OR TORT (INCLUDING NEGLIGENCE OR OTHERWISE) ARISING IN ANY WAY OUT OF THE USE OF THIS SOFTWARE, EVEN IF ADVISED OF THE POSSIBILITY OF SUCH DAMAGE.

- libogg

Copyright (c) 2002, Xiph.org Foundation Redistribution and use in source and binary forms, with or without modification, are permitted provided that the following conditions are met:

– Redistributions of source code must retain the above copyright notice, this list of conditions and the following disclaimer.

– Redistributions in binary form must reproduce the above copyright notice, this list of conditions and the following disclaimer in the documentation and/or other materials provided with the distribution.

– Neither the name of the Xiph.org Foundation nor the names of its contributors may be used to endorse or promote products derived from this software without specific prior written permission.

THIS SOFTWARE IS PROVIDED BY THE COPYRIGHT HOLDERS AND CONTRIBUTORS "AS IS" AND ANY EXPRESS OR IMPLIED WARRANTIES, INCLUDING, BUT NOT LIMITED TO, THE IMPLIED WARRANTIES OF MERCHANTABILITY AND FITNESS FOR A PARTICULAR PURPOSE ARE DISCLAIMED. IN NO EVENT SHALL THE FOUNDATION OR CONTRIBUTORS BE LIABLE FOR ANY DIRECT, INDIRECT, INCIDENTAL, SPECIAL, EXEMPLARY, OR CONSEQUENTIAL DAMAGES (INCLUDING, BUT NOT LIMITED TO, PROCUREMENT OF SUBSTITUTE GOODS OR SERVICES; LOSS OF USE, DATA, OR PROFITS; OR BUSINESS INTERRUPTION) HOWEVER CAUSED AND ON ANY THEORY OF LIABILITY, WHETHER IN CONTRACT, STRICT LIABILITY, OR TORT (INCLUDING NEGLIGENCE OR OTHERWISE) ARISING IN ANY WAY OUT OF THE USE OF THIS SOFTWARE, EVEN IF ADVISED OF THE POSSIBILITY OF SUCH DAMAGE.

■ Informação sobre a forma de deitar fora Velho Equipamento Eléctrico, Electrónico e baterias (aplicável nos países da UE que adoptaram sistemas de recolha de lixos separados)

Produtos e baterias com o símbolo (contentor de lixo com rodas barrado com uma cruz) não podem ser eliminados como lixo doméstico.

Equipamentos velhos eléctricos, electrónicos e baterias deverão ser reciclados num local capaz de o fazer bem assim como os seus subprodutos.

Contacte as autoridades locais para se informar de um local de reciclagem próximo de si.

Reciclagem e tratamento de lixo correctos ajudam a poupar recursos e previnem efeitos prejudiciais na nossa saúde e no ambiente.

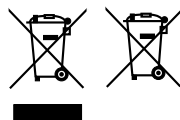



Declaration of Conformity with regard to the Radio Equipment Regulations 2017 (S.I. 2017/1206)

Declaration of Conformity with regard to the Restriction of the Use of Certain Hazardous Substances in Electrical and Electronic Equipment Regulations 2012 (S.I. 2012/3032)

Manufacturer:

JVCKENWOOD Corporation
3-12, Moriya-cho, Kanagawa-ku, Yokohama-shi, Kanagawa,
221-0022, JAPAN

UK Importer:

JVCKENWOOD U.K. Limited
First Floor, Gleneagles, the Belfry, Colonial Way, Watford,
Hertfordshire WD24 4WH, UNITED KINGDOM

Hereby, JVCKENWOOD declares that the radio equipment "KW-M27DBT" is in compliance with the relevant statutory requirements. The full text of the declaration of conformity is available at the following internet address:
URL: <https://www.jvc.net/cs/car/eudoc/>



For Europe sales area

Declaration of Conformity with regard to the RE Directive 2014/53/EU

Declaration of Conformity with regard to the RoHS Directive 2011/65/EU

Manufacturer:

JVCKENWOOD Corporation
3-12, Moriyacho, Kanagawa-ku, Yokohama-shi, Kanagawa
221-0022, JAPAN

EU Representative:

JVCKENWOOD Europe B.V.
Amsterdamseweg 37, 1422 AC UITHOORN, THE
NETHERLANDS

Pour les zones de vente d'Europe

Déclaration de conformité se rapportant à la directive RE 2014/53/UE

Déclaration de conformité se rapportant à la directive RoHS 2011/65/UE

Fabricant:

JVCKENWOOD Corporation
3-12, Moriyacho, Kanagawa-ku, Yokohama-shi, Kanagawa
221-0022, JAPON

Représentant dans l'UE :

JVCKENWOOD Europe B.V.
Amsterdamseweg 37, 1422 AC UITHOORN, PAYS-BAS

**Für das Verkaufsgebiet Europa
Konformitätserklärung in Bezug auf die RE-
Richtlinie 2014/53/EU
Konformitätserklärung in Bezug auf die RoHS-
Richtlinie 2011/65/EU**

Hersteller:

JVCKENWOOD Corporation
3-12, Moriyacho, Kanagawa-ku, Yokohama-shi, Kanagawa
221-0022, JAPAN

EU-Vertreter:

JVCKENWOOD Europe B.V.
Amsterdamseweg 37, 1422 AC UITHOORN, NIEDERLANDE

**Voor Europees verkoopgebied
Conformiteitsverklaring met betrekking tot RE-
richtlijn 2014/53/EU
Conformiteitsverklaring met betrekking tot RoHS-
richtlijn 2011/65/EU**

Fabrikant:

JVCKENWOOD Corporation
3-12, Moriyacho, Kanagawa-ku, Yokohama-shi, Kanagawa
221-0022, JAPAN

EU-vertegenwoordiger:

JVCKENWOOD Europa B.V.
Amsterdamseweg 37, 1422 AC UITHOORN, NEDERLAND

**Per le aree commerciali in Europa
Dichiarazione di conformità relativa alla direttiva
RE 2014/53/UE**

**Dichiarazione di conformità relativa alla direttiva
RoHS 2011/65/UE**

Produttore:

JVCKENWOOD Corporation
3-12, Moriyacho, Kanagawa-ku, Yokohama-shi, Kanagawa
221-0022, JAPAN

Rappresentante UE:

JVCKENWOOD Europe B.V.
Amsterdamseweg 37, 1422 AC UITHOORN, PAESI BASSI

**Para el área de venta de Europa
Declaración de conformidad con respecto a la
Directiva RE 2014/53/UE**

**Declaración de conformidad con respecto a la
Directiva RoHS 2011/65/UE**

Fabricante:

JVCKENWOOD Corporation
3-12, Moriyacho, Kanagawa-ku, Yokohama-shi, Kanagawa
221-0022, JAPAN

Representante en la UE:

JVCKENWOOD Europe B.V.
Amsterdamseweg 37, 1422 AC UITHOORN, PAISES BAJOS

**Para a área de vendas da Europa
Declaração de Conformidade relativa à Diretiva RE
2014/53/UE**

**Declaração de conformidade relativa à Diretiva
RoHS 2011/65/UE**

Fabricante:

JVCKENWOOD Corporation
3-12, Moriyacho, Kanagawa-ku, Yokohama-shi, Kanagawa
221-0022, JAPÃO

Representante na UE:

JVCKENWOOD Europe B.V.
Amsterdamseweg 37, 1422 AC UITHOORN, PAISES BAIXOS

English

Hereby, JVCENWOOD declares that the radio equipment KW-M27DBT is in compliance with Directive 2014/53/EU. The full text of the EU declaration of conformity is available at the following internet address:

Français

Par la présente, JVCENWOOD déclare que l'équipement radio KW-M27DBT est conforme à la directive 2014/53/UE. L'intégralité de la déclaration de conformité UE est disponible à l'adresse Internet suivante :

Deutsch

Hiermit erkläre JVCENWOOD, dass das Funkgerät KW-M27DBT der Richtlinie 2014/53/EU entspricht. Der volle Text der EU-Konformitätserklärung steht unter der folgenden Internetadresse zur Verfügung:

Nederlands

Hierbij verklaart JVCENWOOD dat de radioapparatuur KW-M27DBT in overeenstemming is met Richtlijn 2014/53/EU. De volledige tekst van de EU-verklaring van overeenstemming is te vinden op het volgende internetadres:

Italiano

Con la presente, JVCENWOOD dichiara che l'apparecchio radio KW-M27DBT è conforme alla Direttiva 2014/53/UE. Il testo integrale della dichiarazione di conformità UE è disponibile al seguente indirizzo internet:

Español

Por la presente, JVCENWOOD declara que el equipo de radio KW-M27DBT cumple la Directiva 2014/53/UE. El texto completo de la declaración de conformidad con la UE está disponible en la siguiente dirección de internet:

Português

Deste modo, a JVCENWOOD declara que o equipamento de rádio KW-M27DBT está em conformidade com a Diretiva 2014/53/UE. O texto integral da declaração de conformidade da UE está disponível no seguinte endereço de internet:

Polska

Niniejszym, JVCENWOOD deklaruje, że sprzęt radiowy KW-M27DBT jest zgodny z dyrektywą 2014/53/UE. Pełny tekst deklaracji zgodności EU jest dostępny pod adresem:

Český

Společnost JVCENWOOD tímto prohlašuje, že rádiové zařízení KW-M27DBT splňuje podmínky směrnice 2014/53/UE. Plný text EU prohlášení o shodě je dostupný na následující internetové adrese:

Magyar

JVCENWOOD ezennel kijelenti, hogy a KW-M27DBT rádióberendezés megfelel a 2014/53/EU irányelvnek. Az EU konformitási nyilatkozat teljes szövege az alábbi weboldalon érhető el:

Hrvatski

JVCENWOOD ovim izjavljuje da je radio oprema KW-M27DBT u skladu s Direktivom 2014/53/EU. Cjeloviti tekst deklaracije Europske unije o usklađenosti dostupan je na sljedećoj internet adresi:

Svenska

Härmed försäkras JVCENWOOD att radioutrustningen KW-M27DBT är i enlighet med direktiv 2014/53 / EU. Den fullständiga texten av EU-försäkran om överensstämmelse finns på följande Internetadress :

Suomi

JVCENWOOD julistaa täten, että radiolaitte KW-M27DBT on direktiivin 2014/53/EU mukainen. EU-vaatimustenmukaisuusvakuutus löytyy kokonaisuudessaan seuraavasta internet-osoitteesta:

Slovensko

S tem JVCENWOOD izjavlja, da je radijska oprema KW-M27DBT v skladu z Direktivo 2014/53/EU. Celotno besedilo direktive EU o skladnosti je dostopno

na tem spletnem naslovu:

Slovensky

Spoločnosť JVCENWOOD týmto vyhlasuje, že rádiové zariadenie KW-M27DBT vyhovuje smernici 2014/53/EU. Celý text EU vyhlásenia o zhode nájdete na nasledovnej internetovej adrese:

Dansk

Herved erklærer JVCENWOOD, at radioustyret KW-M27DBT er i overensstemmelse med Direktiv 2014/53/EU. EU-overensstemmelseserklæringens fulde ordlyd er tilgængelig på følgende internetadresse:

Norsk

JVCENWOOD erklærer herved at radioustyret KW-M27DBT er i samsvar med Direktiv 2014/53/EU. Den fullstendige teksten til EU-konformitetserklæringen er tilgjengelig på følgende internettadresse:

Ελληνικά

Με το παρόν, η JVCENWOOD δηλώνει ότι ο ραδιοεξοπλισμός KW-M27DBT συμμορφώνεται με την Οδηγία 2014/53/ΕΕ. Το πλήρες κείμενο της δήλωσης συμμόρφωσης της ΕΕ είναι διαθέσιμο στην ακόλουθη διεύθυνση στο διαδίκτυο:

Eesti

Käesolevaga JVCENWOOD kinnitab, et KW-M27DBT raadiovarustus on vastavuses direktiiviga 2014/53/EL. ELi vastavusdeklaratsiooni terviktekst on kättesaadav järgmisel internetiaadressil:

Latviešu

JVCENWOOD ar šo deklarē, ka radio aparatūra KW-M27DBT atbilst direktīvas 2014/53/ES prasībām. Pilns ES atbilstības deklarācijas teksts ir pieejams šādā tīmekļa adresē:

Lietuviškai

Šiuo JVCENWOOD pažymi, kad radijo įranga KW-M27DBT atitinka 2014/53/EB direktyvos reikalavimus. Visą EB direktyvos atitikties deklaracijos tekstą galite rasti šiuo internetiniu adresu:

Malti

B'dan, JVCENWOOD jiddikjara li t-tagħmir tar-radjju KW-M27DBT huwa konformi mad-Direttiva 2014/53/UE. It-test kollu tad-dikjarazzjoni ta' konformità huwa disponibbli fl-indirizz intranet li ġej:

Українська

Таким чином, компанія JVCENWOOD заявляє, що радіобладнання KW-M27DBT відповідає Директиві 2014/53/ЕU. Повний текст декларації про відповідність ЄС можна знайти в Інтернеті за такою адресою:

Türkçe

Burada, JVCENWOOD KW-M27DBT radyo ekipmanının 2014/53/AB Direktifine uygun olduğunu bildirir. AB uyumluluk deklarasyonunun tam metni aşağıdaki internet adresinde mevcuttur.

Русский

JVCENWOOD настоящим заявляет, что радиооборудование KW-M27DBT соответствует Директиве 2014/53/EU. Полный текст декларации соответствия ЕС доступен по следующему адресу в сети Интернет:

Limba română

Prin prezenta, JVCENWOOD declară că echipamentul radio KW-M27DBT este în conformitate cu Directiva 2014/53/UE. Textul integral al declarației de conformitate UE este disponibil la următoarea adresă de internet:

Български език

С настоящото JVCENWOOD декларира, че радиооборудването на KW-M27DBT е в съответствие с Директива 2014/53/ЕС. Пълният текст на ЕС декларацията за съответствие е достъпен на следния интернет адрес:

URL: <https://www.jvc.net/cs/car/eudoc/>

JVC